

---

---

# APIs for Test Automation and Remote Access

---

---



818 West Diamond Avenue - Third Floor, Gaithersburg, MD 20878  
Phone: (301) 670-4784 Fax: (301) 670-9187 Email: [info@gl.com](mailto:info@gl.com)  
Website: <http://www.gl.com>

# PacketExpert™ 10GX - Portable Unit (PXN100, PXN101)

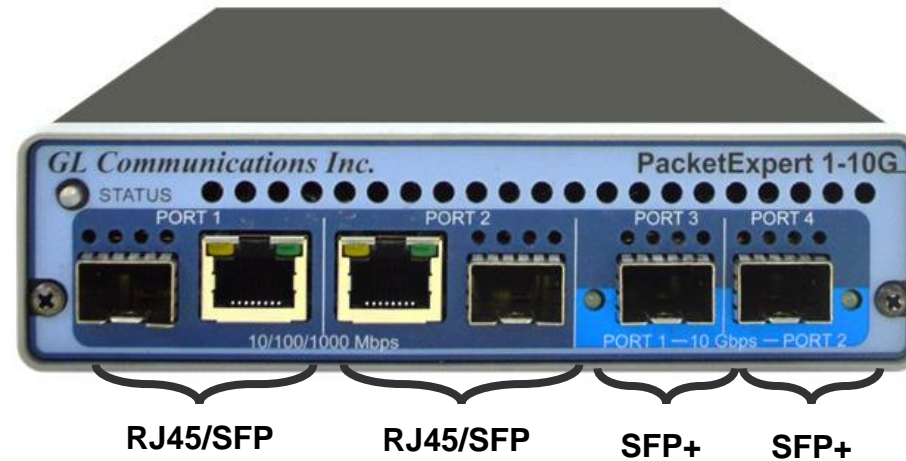

Physical Specifications	<ul style="list-style-type: none"> <li>• Length: 8.45 in (214.63 mm)</li> <li>• Width: 5.55 in (140.97 mm)</li> <li>• Height: 1.60 in (40.64 mm)</li> <li>• Weight: 1.713 lbs</li> </ul>
External Power Supply	<ul style="list-style-type: none"> <li>• +12 Volts (Medical Grade), 3 Amps (For portable units having serial number <math>\geq</math> 188400)</li> <li>• +9 Volts, 2 Amps (For portable units having serial number <math>&lt;</math> 188400)</li> </ul>
BUS Interface	<ul style="list-style-type: none"> <li>• USB 3.0</li> <li>• Optional 4-Port SMA Jack Trigger Board(TTL Input/Output)</li> </ul>
Protocols	<ul style="list-style-type: none"> <li>• IEEE 802.3ae LAN PHY compliance</li> <li>• RFC 2544 compliance</li> </ul>

# PacketExpert™ Software



Windows 7/8/10 64-bit OS

USB 3.0

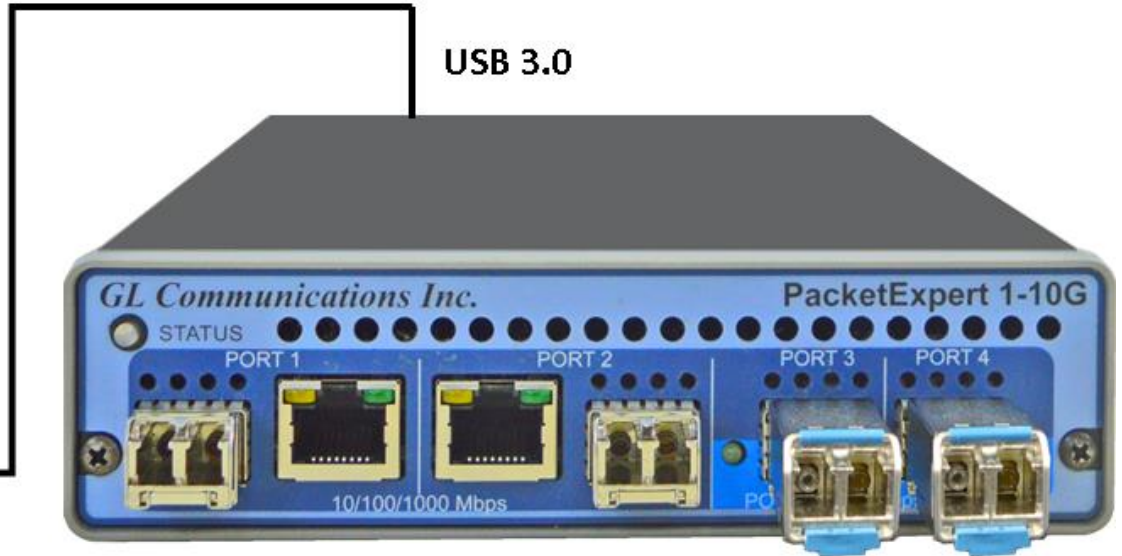

USB 3.0

# PacketExpert™ 10GX - Optical Ports

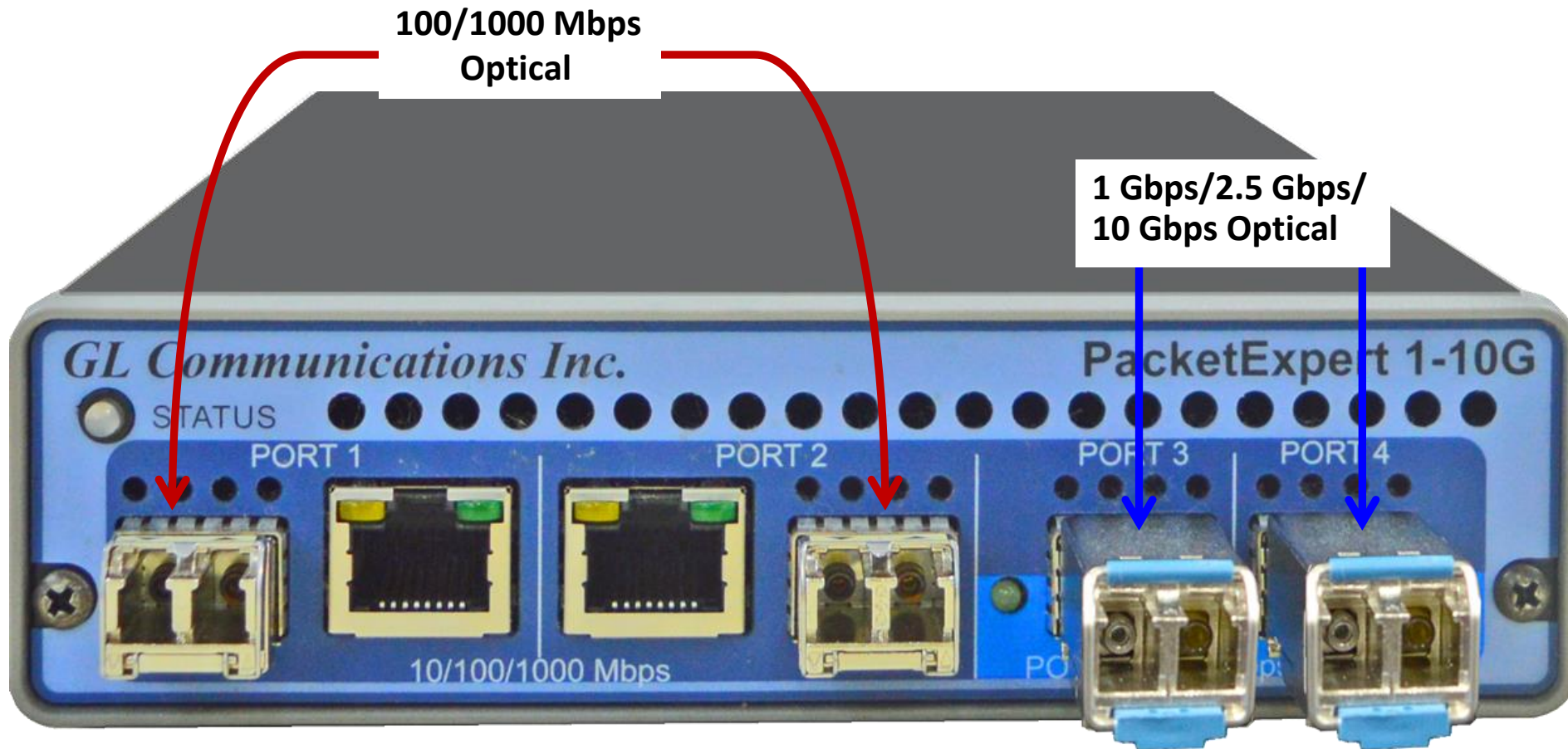



# PacketExpert™ 10GX - Electrical Ports

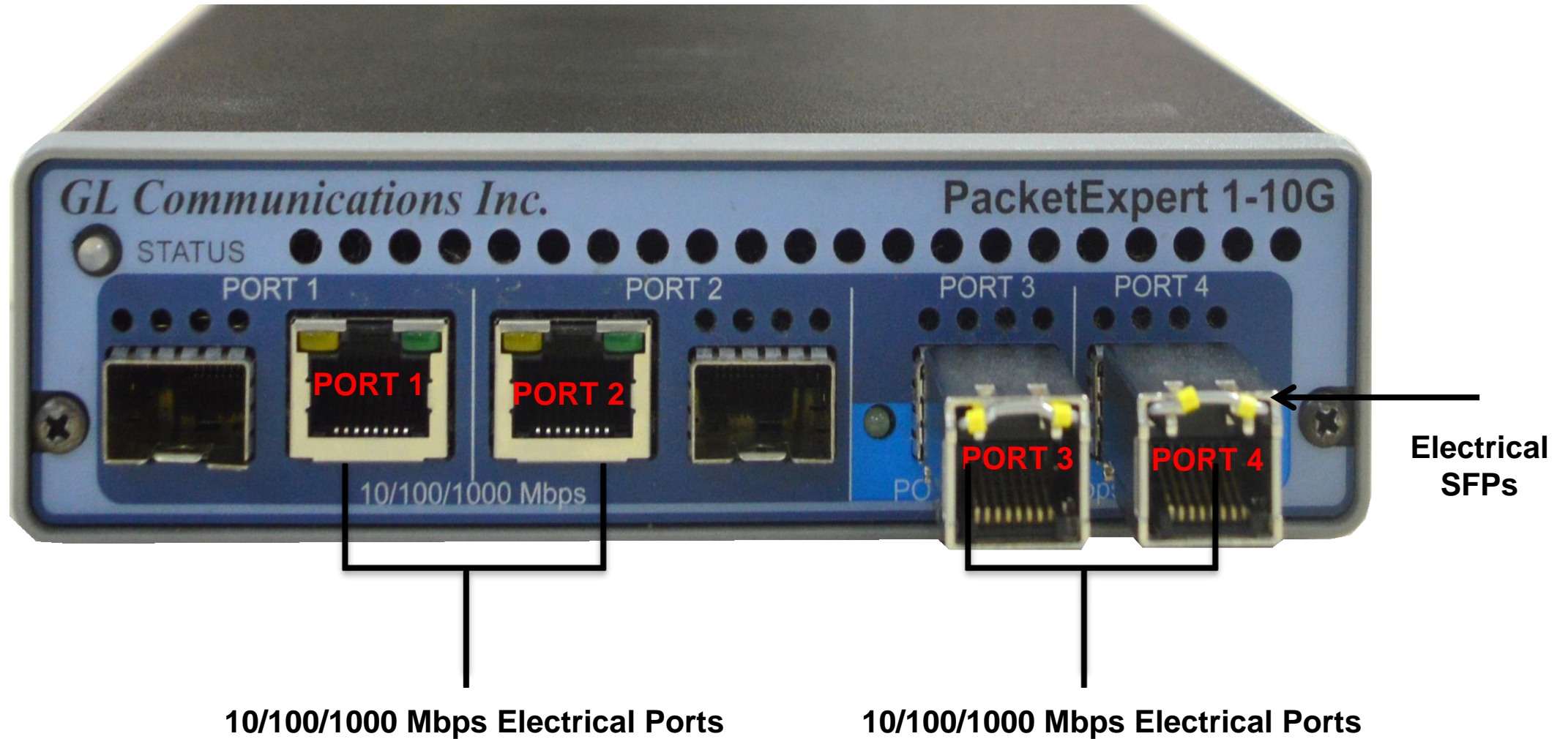

10/100/1000 Mbps Electrical Ports

10/100/1000 Mbps Electrical Ports

Electrical SFPs

# mTOP™ 1U Rack Option with 12 TTL

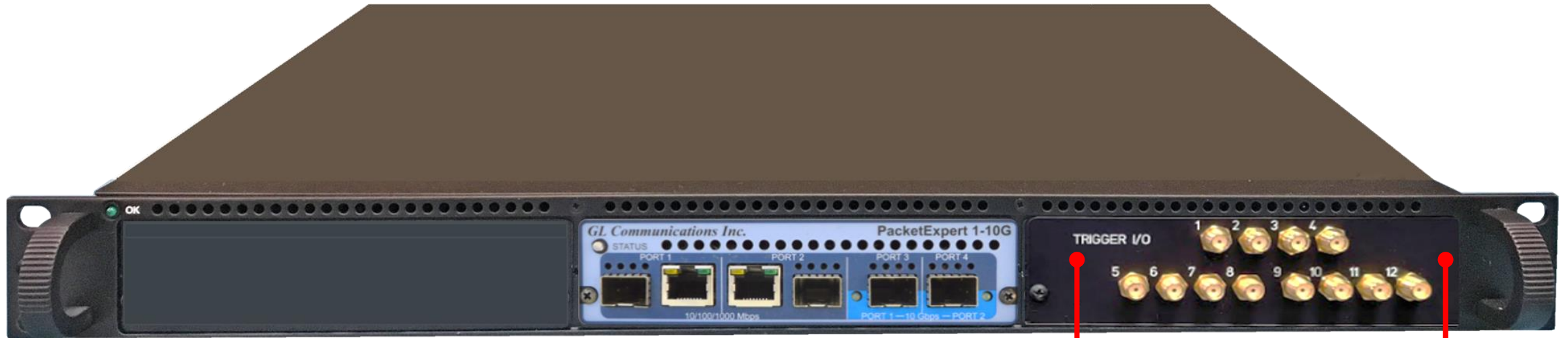

1 to 12 TTL  
Programmable I/O

# MTOP™ Rack Units



**High Density 1U Rack option**

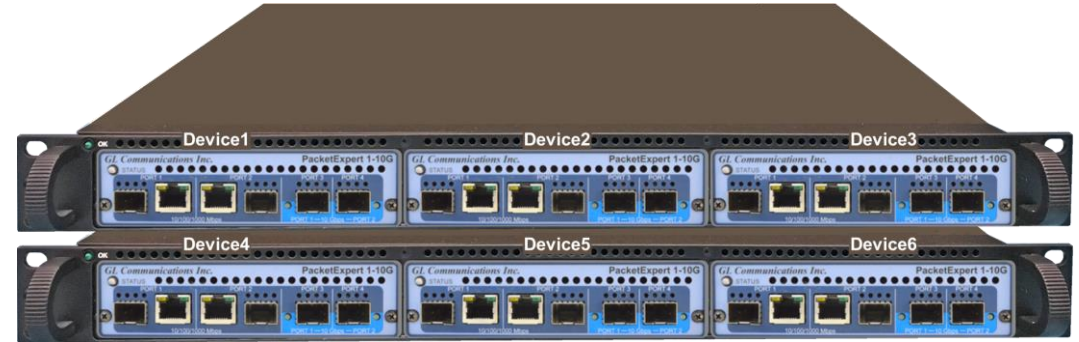

**Stacked High Density 1U Rack option**

Physical Specifications	<ul style="list-style-type: none"> <li>• Length: 16 in (406.4)</li> <li>• Width: 19 in (482.6)</li> <li>• Height: 1U / 2U</li> </ul>
External Power Supply	<ul style="list-style-type: none"> <li>• ATX Power Supply</li> </ul>
BUS Interface	<ul style="list-style-type: none"> <li>• 1U mTOP™ (MT001 + 3x PXN100)                             <ul style="list-style-type: none"> <li>➤ Rackmount Enclosure can support up to 3 PXN100s</li> </ul> </li> <li>• 2U Rack Mount (with 6x PXN100)                             <ul style="list-style-type: none"> <li>➤ Rackmount Enclosure can support up to 6 PXN100s</li> </ul> </li> <li>• Optional 4 to 12 Port SMA Jack Trigger Board (TTL Input/Output)</li> </ul>
SBC Specifications	<ul style="list-style-type: none"> <li>• Intel Core i3 or optional i7 NUC Equivalent,</li> <li>• Windows® 11 64-bit Pro Operating System</li> <li>• USB 3.0 and USB 2.0 Ports, ATX Power Supply</li> <li>• USB Type C Ports, Ethernet 2.5GigE port</li> <li>• 256 GB Hard drive, 8G Memory (Min)</li> <li>• Two HDMI ports</li> </ul>



# mTOP™ 1U Rack Option with Built in SBC

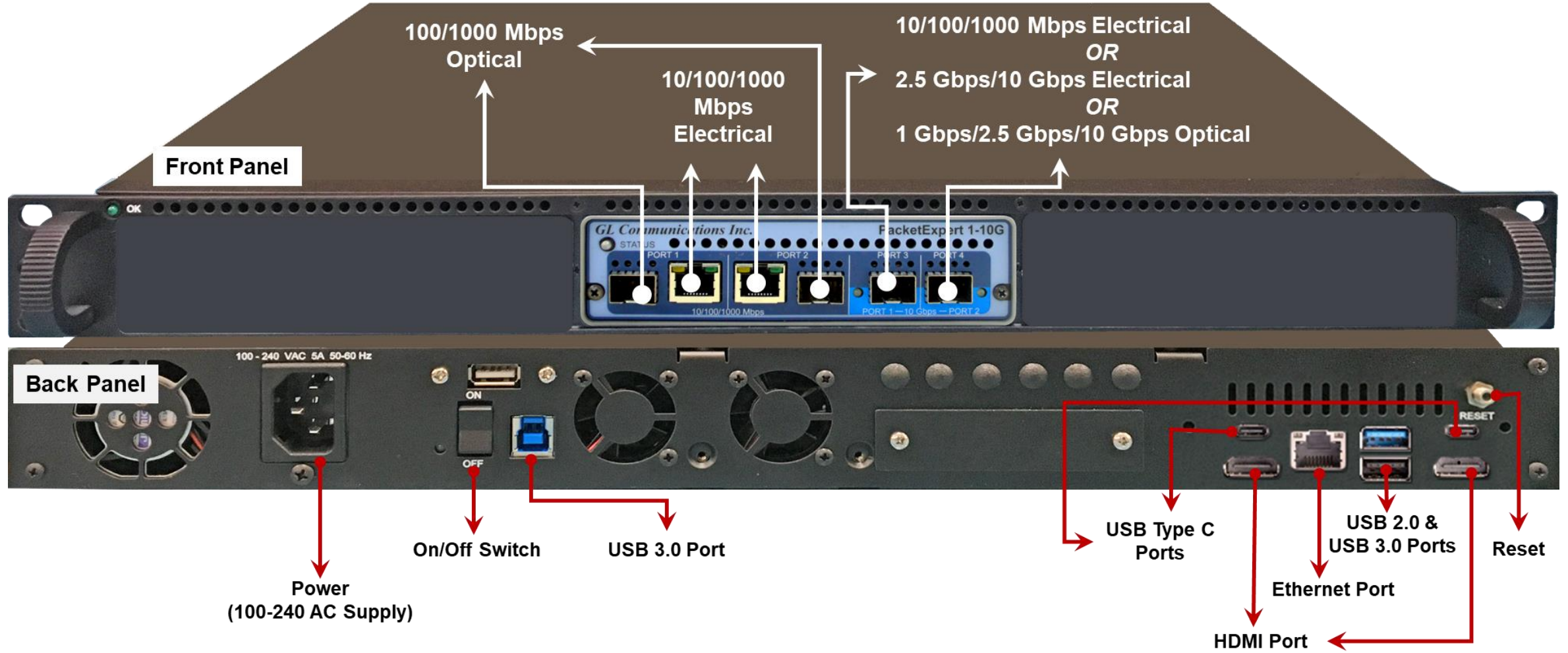



# mTOP™ Probe with 10GX Hardware Unit + SBC

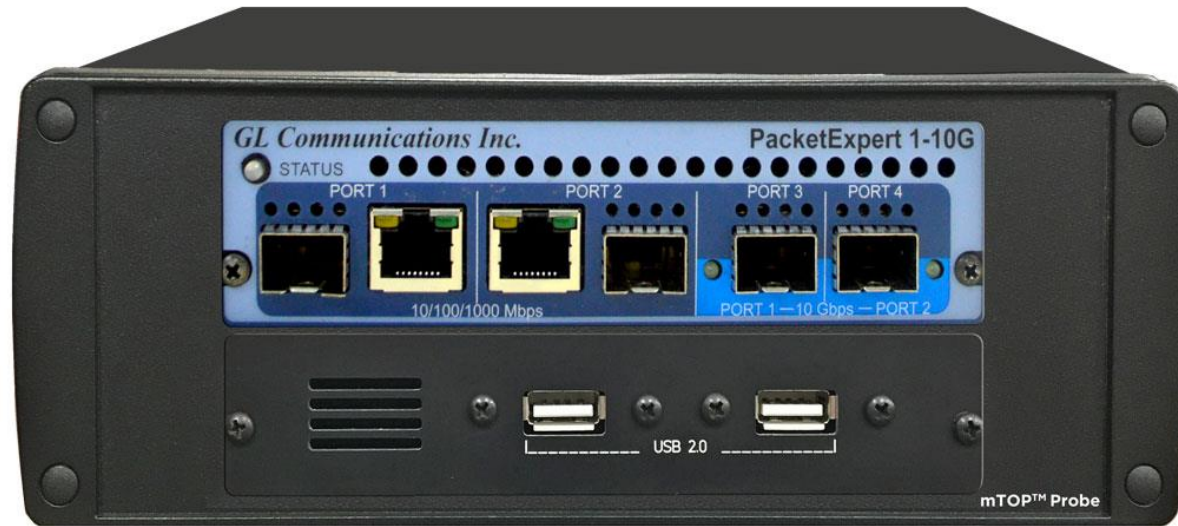

Physical Specifications	<ul style="list-style-type: none"><li>• Length: 10.4 in. (264.16 mm)</li><li>• Width: 8.4 in. (213.36 mm)</li><li>• Height: 3.0 in. (76.2 mm)</li><li>• Optional 4-Port SMA Jack Trigger Board (TTL Input/Output)</li><li>• External USB based Wi-Fi adaptor</li></ul>
External Power Supply	<ul style="list-style-type: none"><li>• +12 Volts (Medical Grade), 3 Amps</li></ul>
SBC Specifications	<ul style="list-style-type: none"><li>• Intel Core i3 or optional i7 NUC Equivalent,</li><li>• Windows® 11 64-bit Pro Operating System</li><li>• USB 2.0 and 3.0 Ports, 12V/ 3Amps Power Supply</li><li>• USB Type C Ports, Ethernet 2.5GigE port</li><li>• 256 GB Hard drive, 8G Memory (Min)</li><li>• Two HDMI ports</li></ul>

# Optical Connectors and SFP Transceivers

LC Connectors

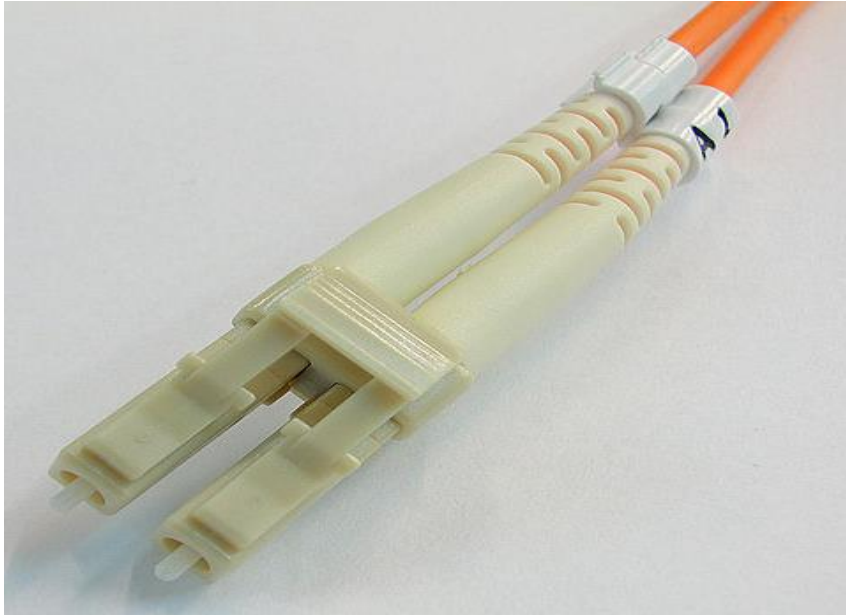

850nm/1310nm/1550nm

SFP Module



- PacketExpert™ 10GX supports LC connectors and 850nm/1310nm/1550nm SFP (Small Factor Pluggable) modules

**Note:** In case customer have different type of connectors, then we need converters like LC-to-SC, LC-to-FC and vice-versa

# Applications

- Test and verify QoS Parameters of network devices like Switches/Routers etc.
- End to end testing of network paths for QoS parameters
- In-depth troubleshooting of the Carrier network in the event of network failures or impairments
- QoS testing of Triple-play services to ensure that they fully qualify SLA parameters
- Terrestrial wireless, satellite, and other WAN technologies network validations
- Test VoIP network in real-time conditions to verify if it meets the quality requirements before you deploy
- Testing video on IP networks by emulating the loss and congestion characteristics
- SPF support can be used for Broadband aggregation applications, Metro edge switching, Metro and access multi-service platforms, and are suitable for Fast Ethernet applications

# PacketExpert™ APIs for Test Automation and Remote Access

- Overview
- Features
- Working principle
- MAPS™ CLI Server – API Clients
- Typical Test Systems
- IPLinkSim
- ITU-T Y.1564 (ExpertSAM™)
- Wire-Speed Record / Playback
- PacketBroker
- Multi-Stream Traffic Generator Analyzer
- RFC-6349 based TCP Throughput Testing (ExpertTCP™)



# Overview

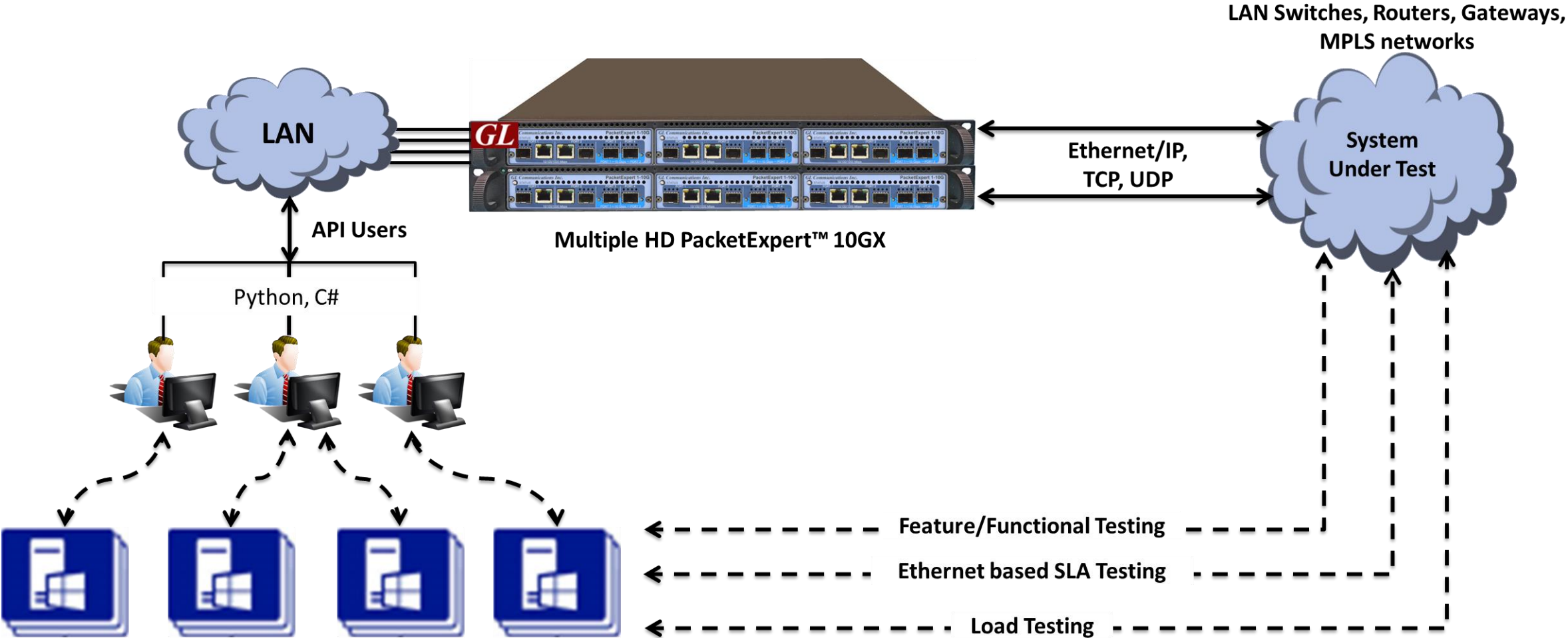

# Overview

- With additional licensing, PacketExpert™ supports Command line Interface (CLI) to access all the functionalities remotely such as Bert, Loopback, RFC 2544, Record Playback, IPNetSim™, ExpertSAM™, PacketBroker™, and Multi Stream Traffic Generator and Analyzer using Python, C# client APIs and MAPS™ CLI Client/Server architecture
- PacketExpert™ can be configured as server-side application using the GL's MAPS™ Client-Server architecture, to provide the capability of remote operation, automation, and multi-site connectivity, using any client-side scripting tools such as the Python, C#
- On the client side, the packaged library file is provided which allows the client interface to communicate with the MAPS™ CLI Server to perform PacketExpert™ specific functionalities

# Features

- Capability of remote operation, automation and multi-site connectivity using Python/C# client and MAPS™ CLI server
- Scripts for MAC, VLAN, MPLS, IP and UDP layers testing
- Multiple PacketExpert™ can be controlled remotely from single client application via MAPS™ CLI server
- Scripts for Bert, Loopback, RFC 2544, Record Playback, IPLinkSim™, PacketBroker™, WAN Link Emulation, Multi-stream Traffic Generation and Analysis, and ExpertSAM™ testing

# Working Principle of MAPS™ CLI

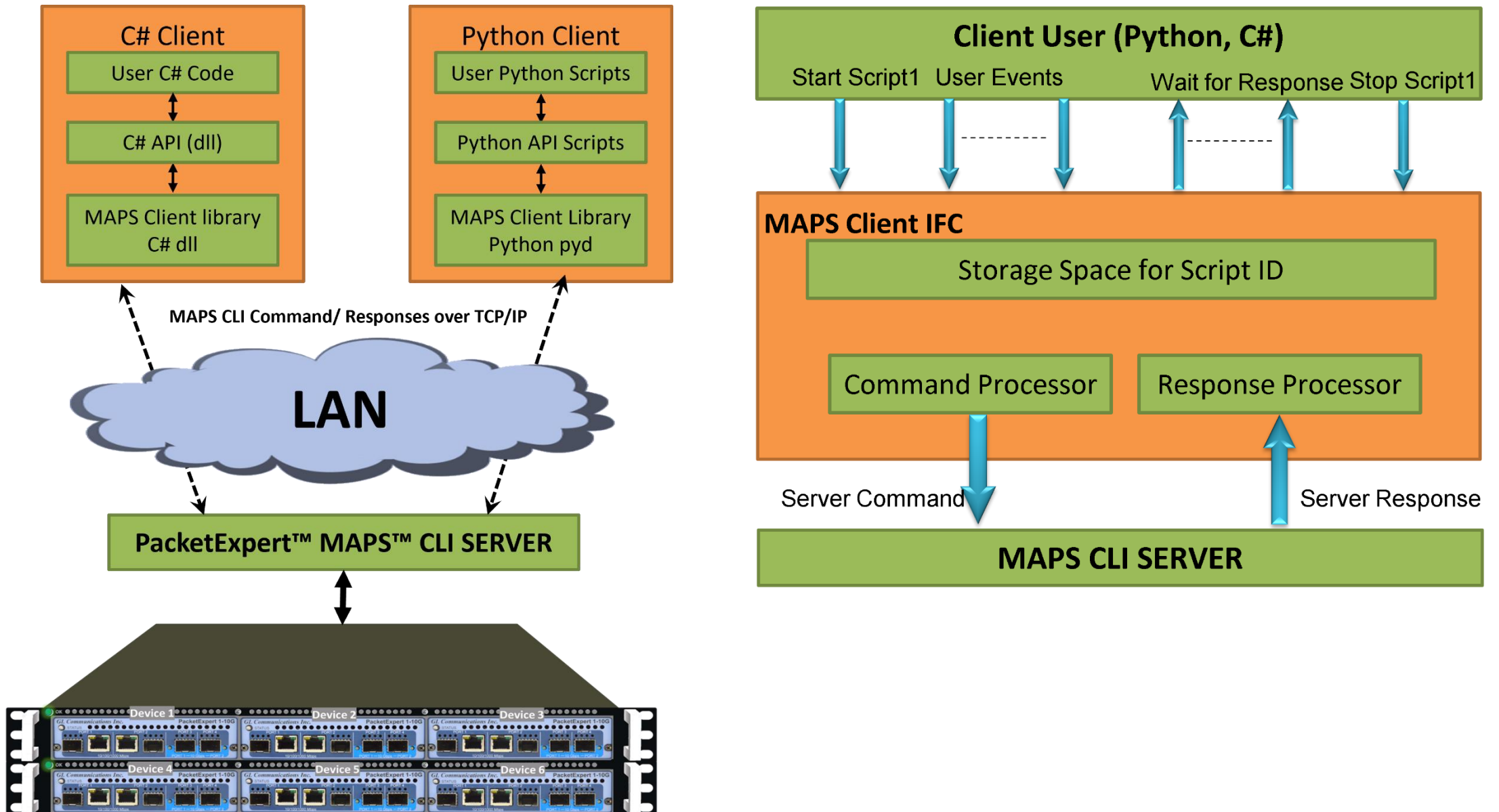



# MAPS™ CLI Server

- GL's proprietary MAPS™ CLI Server scripts (\*.gls files) developed specifically for PacketExpert™ implements various PacketExpert™ functionalities like BERT, RFC 2544, and others
- MAPS™ CLI Server interfaces internally with low level PacketExpert™ APIs to access PacketExpert™ hardware and to perform tasks

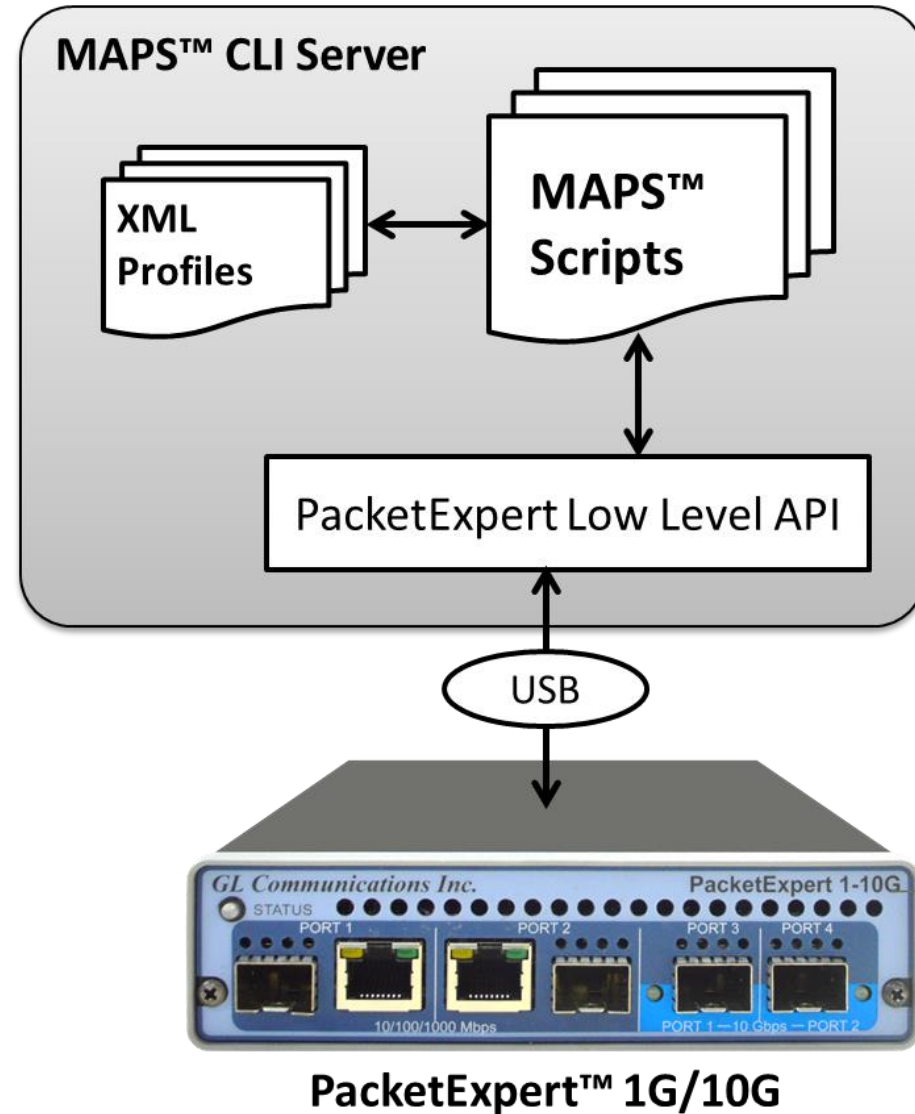

# MAPS™ CLI Server (Contd.)

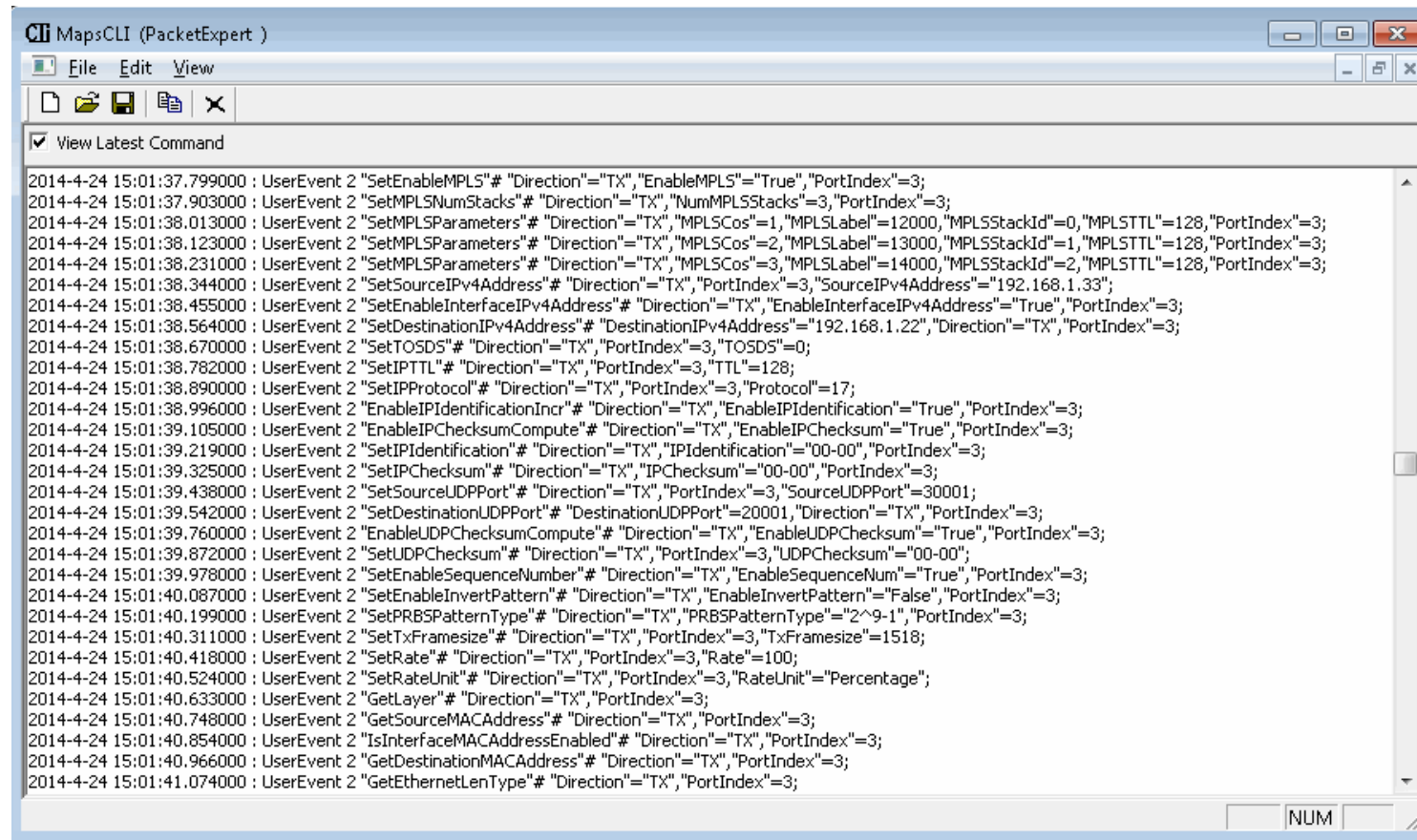

```
2014-4-24 15:01:37.799000 : UserEvent 2 "SetEnableMPLS"# "Direction"="TX","EnableMPLS"="True","PortIndex"=3;
2014-4-24 15:01:37.903000 : UserEvent 2 "SetMPLSNumStacks"# "Direction"="TX","NumMPLSStacks"=3,"PortIndex"=3;
2014-4-24 15:01:38.013000 : UserEvent 2 "SetMPLSParameters"# "Direction"="TX","MPLSCos"=1,"MPLSLabel"=12000,"MPLSStackId"=0,"MPLSTTL"=128,"PortIndex"=3;
2014-4-24 15:01:38.123000 : UserEvent 2 "SetMPLSParameters"# "Direction"="TX","MPLSCos"=2,"MPLSLabel"=13000,"MPLSStackId"=1,"MPLSTTL"=128,"PortIndex"=3;
2014-4-24 15:01:38.231000 : UserEvent 2 "SetMPLSParameters"# "Direction"="TX","MPLSCos"=3,"MPLSLabel"=14000,"MPLSStackId"=2,"MPLSTTL"=128,"PortIndex"=3;
2014-4-24 15:01:38.344000 : UserEvent 2 "SetSourceIPv4Address"# "Direction"="TX","PortIndex"=3,"SourceIPv4Address"="192.168.1.33";
2014-4-24 15:01:38.455000 : UserEvent 2 "SetEnableInterfaceIPv4Address"# "Direction"="TX","EnableInterfaceIPv4Address"="True","PortIndex"=3;
2014-4-24 15:01:38.564000 : UserEvent 2 "SetDestinationIPv4Address"# "DestinationIPv4Address"="192.168.1.22","Direction"="TX","PortIndex"=3;
2014-4-24 15:01:38.670000 : UserEvent 2 "SetTOSDS"# "Direction"="TX","PortIndex"=3,"TOSDS"=0;
2014-4-24 15:01:38.782000 : UserEvent 2 "SetIPTTL"# "Direction"="TX","PortIndex"=3,"TTL"=128;
2014-4-24 15:01:38.890000 : UserEvent 2 "SetIPProtocol"# "Direction"="TX","PortIndex"=3,"Protocol"=17;
2014-4-24 15:01:38.996000 : UserEvent 2 "EnableIPIdentificationIncr"# "Direction"="TX","EnableIPIdentification"="True","PortIndex"=3;
2014-4-24 15:01:39.105000 : UserEvent 2 "EnableIPChecksumCompute"# "Direction"="TX","EnableIPChecksum"="True","PortIndex"=3;
2014-4-24 15:01:39.219000 : UserEvent 2 "SetIPIdentification"# "Direction"="TX","IPIdentification"="00-00","PortIndex"=3;
2014-4-24 15:01:39.325000 : UserEvent 2 "SetIPChecksum"# "Direction"="TX","IPChecksum"="00-00","PortIndex"=3;
2014-4-24 15:01:39.438000 : UserEvent 2 "SetSourceUDPPort"# "Direction"="TX","PortIndex"=3,"SourceUDPPort"=30001;
2014-4-24 15:01:39.542000 : UserEvent 2 "SetDestinationUDPPort"# "DestinationUDPPort"=20001,"Direction"="TX","PortIndex"=3;
2014-4-24 15:01:39.760000 : UserEvent 2 "EnableUDPChecksumCompute"# "Direction"="TX","EnableUDPChecksum"="True","PortIndex"=3;
2014-4-24 15:01:39.872000 : UserEvent 2 "SetUDPChecksum"# "Direction"="TX","PortIndex"=3,"UDPChecksum"="00-00";
2014-4-24 15:01:39.978000 : UserEvent 2 "SetEnableSequenceNumber"# "Direction"="TX","EnableSequenceNum"="True","PortIndex"=3;
2014-4-24 15:01:40.087000 : UserEvent 2 "SetEnableInvertPattern"# "Direction"="TX","EnableInvertPattern"="False","PortIndex"=3;
2014-4-24 15:01:40.199000 : UserEvent 2 "SetPRBSPatternType"# "Direction"="TX","PRBSPatternType"="2^9-1","PortIndex"=3;
2014-4-24 15:01:40.311000 : UserEvent 2 "SetTxFramesize"# "Direction"="TX","PortIndex"=3,"TxFramesize"=1518;
2014-4-24 15:01:40.418000 : UserEvent 2 "SetRate"# "Direction"="TX","PortIndex"=3,"Rate"=100;
2014-4-24 15:01:40.524000 : UserEvent 2 "SetRateUnit"# "Direction"="TX","PortIndex"=3,"RateUnit"="Percentage";
2014-4-24 15:01:40.633000 : UserEvent 2 "GetLayer"# "Direction"="TX","PortIndex"=3;
2014-4-24 15:01:40.748000 : UserEvent 2 "GetSourceMACAddress"# "Direction"="TX","PortIndex"=3;
2014-4-24 15:01:40.854000 : UserEvent 2 "IsInterfaceMACAddressEnabled"# "Direction"="TX","PortIndex"=3;
2014-4-24 15:01:40.966000 : UserEvent 2 "GetDestinationMACAddress"# "Direction"="TX","PortIndex"=3;
2014-4-24 15:01:41.074000 : UserEvent 2 "GetEthernetLenType"# "Direction"="TX","PortIndex"=3;
```

- CLI Server script execution is Event Driven, i.e., Server detects the Events such as InsertStatus, InterfaceStatus, IsRunning, LoadProfileStatus, RFC2544Init, RFC2544TestConfig, TestDirection and others

# Python Client and Scripting

- The Python Client consists of following components:
- Python API scripts, that provide High Level APIs, using which all the PacketExpert™ functionalities are accessible to the users
- These APIs in turn use a low level library to communicate with the PacketExpert™ MAPS™ server

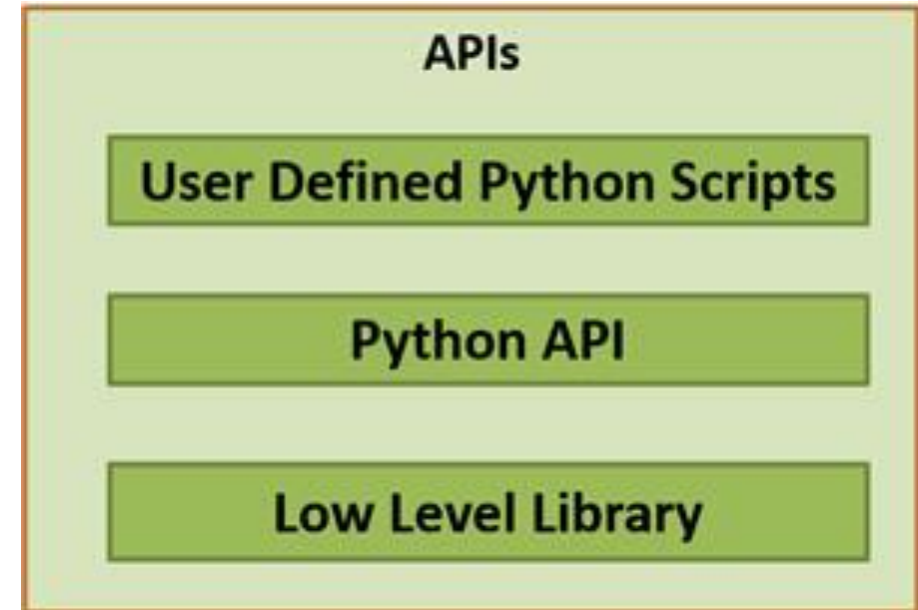

# Python Client

```
Run: AllPortBert_SampleApplication x AllPortBert_SampleApplication x
AllPortBert application Initialised
Press any key to continue , 'q' to quit
Running BERT Test
Loading Configuration
*****Device 1 *****
Load Configuration Done
*****Ports Interface Information*****
*****Device 1 *****
['Up', '00-21-C2-00-09-B4', 'ELECTRICAL', 'Complete', '1000Mbps', 'Full Duplex', 'Enabled']
['Up', '00-21-C2-00-09-B5', 'ELECTRICAL', 'Complete', '1000Mbps', 'Full Duplex', 'Enabled']
['Up', '00-21-C2-00-09-B6', 'ELECTRICAL', 'Complete', '1000Mbps', 'Full Duplex', 'Enabled']
['Up', '00-21-C2-00-09-B7', 'ELECTRICAL', 'Complete', '1000Mbps', 'Full Duplex', 'Enabled']
*****Device 1 *****
Port : 1 Rx Started
Port : 2 Rx Started
Port : 3 Rx Started
Port : 4 Rx Started
Port : 1 Tx Started
Port : 2 Tx Started
Port : 3 Tx Started
Port : 4 Tx Started
```

```
Port : 4 Tx Started
*****Device 1 *****
Bert Results of Port 1
[{'Traffic Status': 'Rx Traffic'},
 {'Sync Status': 'InSync'},
 {'Bit Error Status': 'No Error'},
 {'Out Of Sequence Status': 'No Error'},
 {'BERT Status': 'Sync'},
 {'BERT Test Time': '00:00:07'},
 {'Bits Received': '5 226 410 336'},
 {'Bit Error Count': '0'},
 {'Bit Error Rate': '0.000E+00'},
 {'Bit Error Seconds': '0'},
 {'Sync Loss Count': '0'},
 {'Sync Loss Seconds': '0'},
 {'Out of Sequence Count': '0'},
 {'Out of Sequence Seconds': '0'},
 {'Error Free Seconds': '7'}]
```

```
Bert Results of Port 2
[{'Traffic Status': 'Rx Traffic'},
 {'Sync Status': 'InSync'},
 {'Bit Error Status': 'No Error'},
 {'Out Of Sequence Status': 'No Error'},
 {'BERT Status': 'Sync'},
 {'BERT Test Time': '00:00:07'},
```



# C# Client and Scripting

- The C# interface developed for PacketExpert™ allows users to control all features of PacketExpert™ through C# APIs
- The C# client connects to the MAPS™ CLI server using TCP/IP sockets

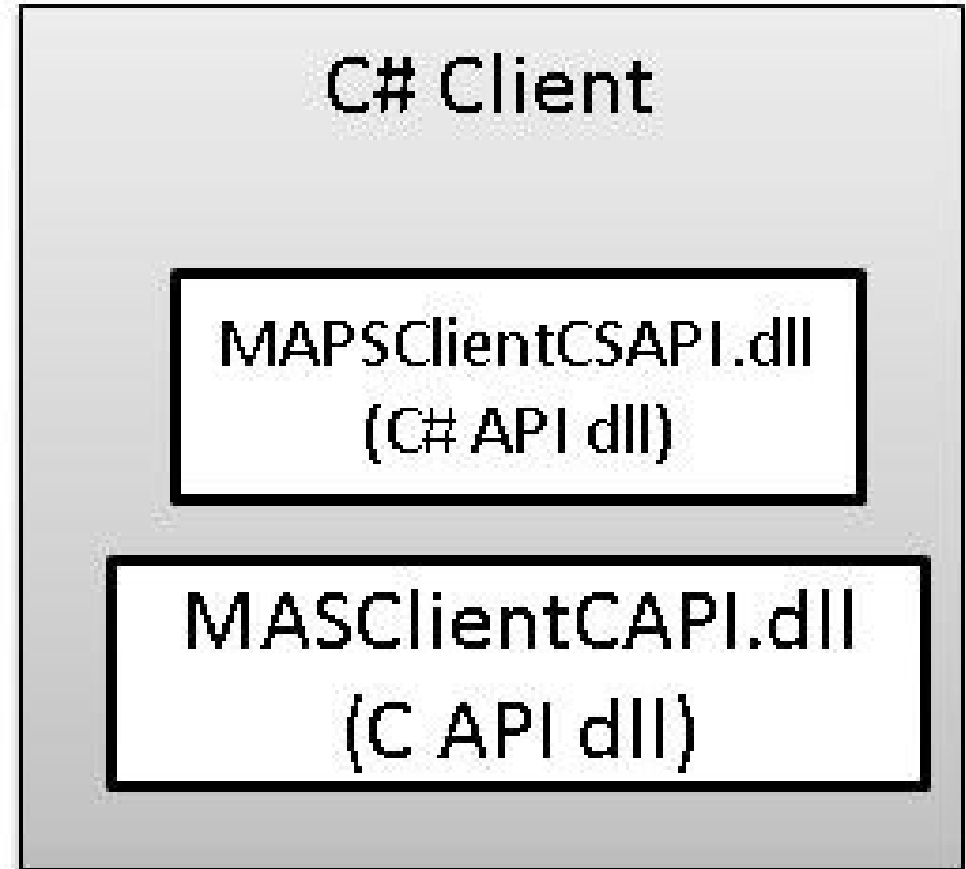

# C# Client

C:\Program Files\GL Communications Inc\PacketExpertPxeClient\C#\AllPortBert\_ConsoleApplication.exe

```
Port3
Traffic Status: Rx Traffic
Sync Status: InSync
Bit Error Status: No Error
Out Of Sequence Status: No Error
BERT Status: Sync
BERT Test Time: 00:00:18
Bits Received: 17 012 794 104
Bit Error Count: 0
Bit Error Rate: 0.000E+00
Bit Error Seconds: 0
Sync Loss Count: 0
Sync Loss Seconds: 0
Out of Sequence Count: 0
Out of Sequence Seconds: 0
Error Free Seconds: 19
```

```
Port4
Traffic Status: Rx Traffic
Sync Status: InSync
Bit Error Status: No Error
Out Of Sequence Status: No Error
BERT Status: Sync
BERT Test Time: 00:00:18
Bits Received: 17 071 621 200
Bit Error Count: 0
Bit Error Rate: 0.000E+00
Bit Error Seconds: 0
Sync Loss Count: 0
Sync Loss Seconds: 0
```

# PacketExpert™ Integration with LabVIEW using C# Client

## PacketExpert™ Integration with LabVIEW

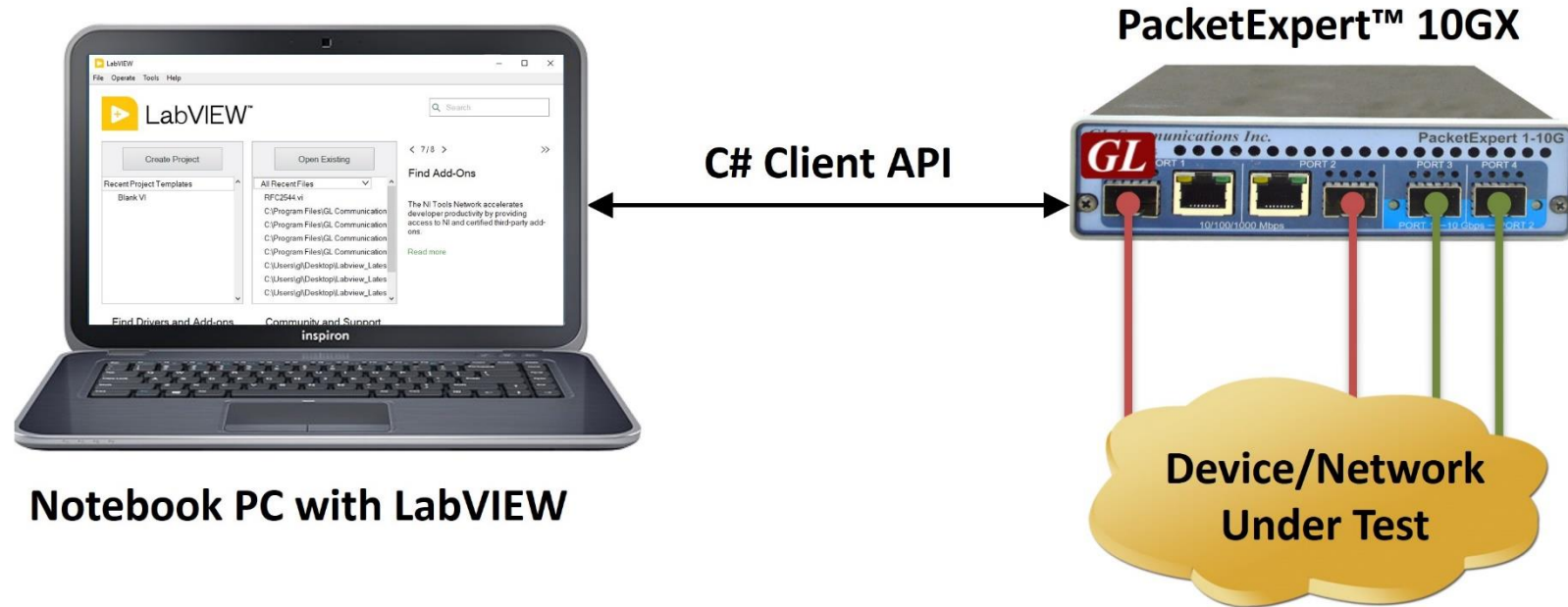

# PacketExpert™ Integration with LabVIEW using C# Client

## BERT Statistics

### BERT Results

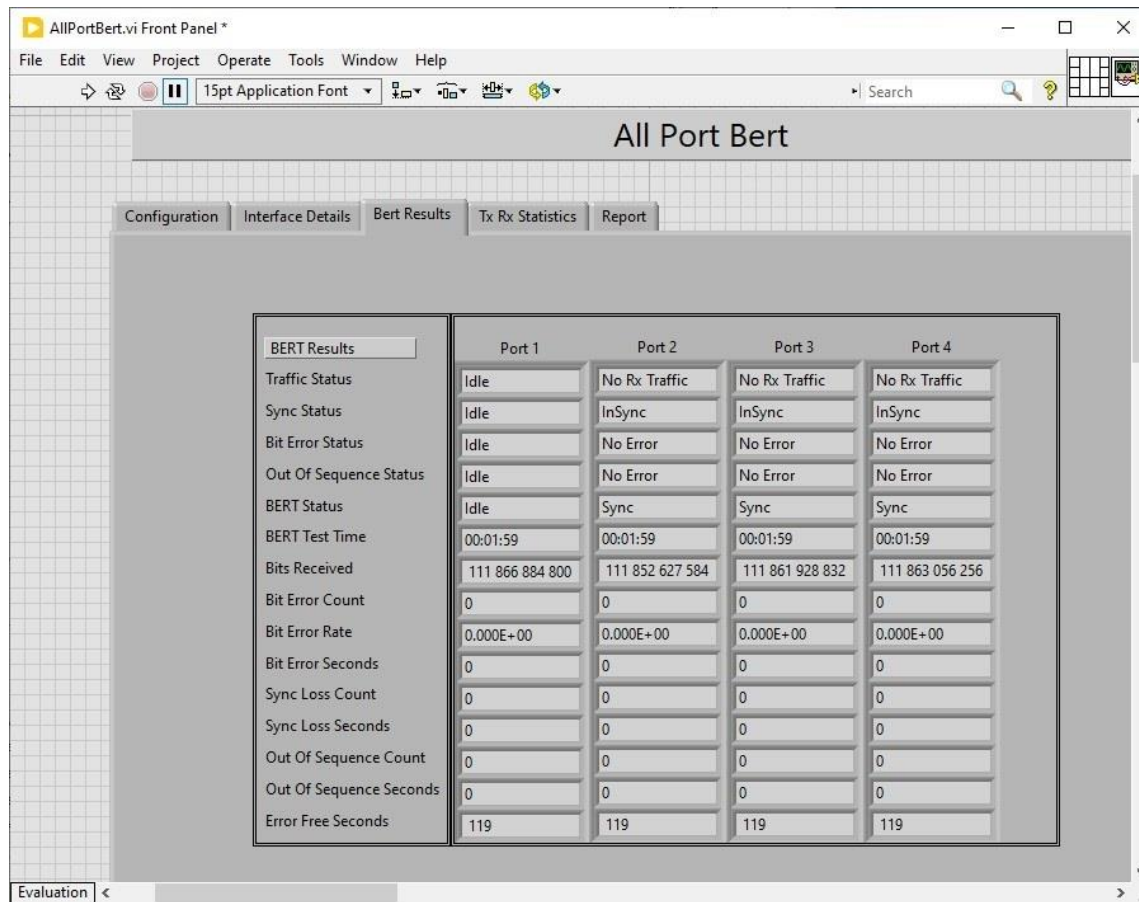



**Thank You**