

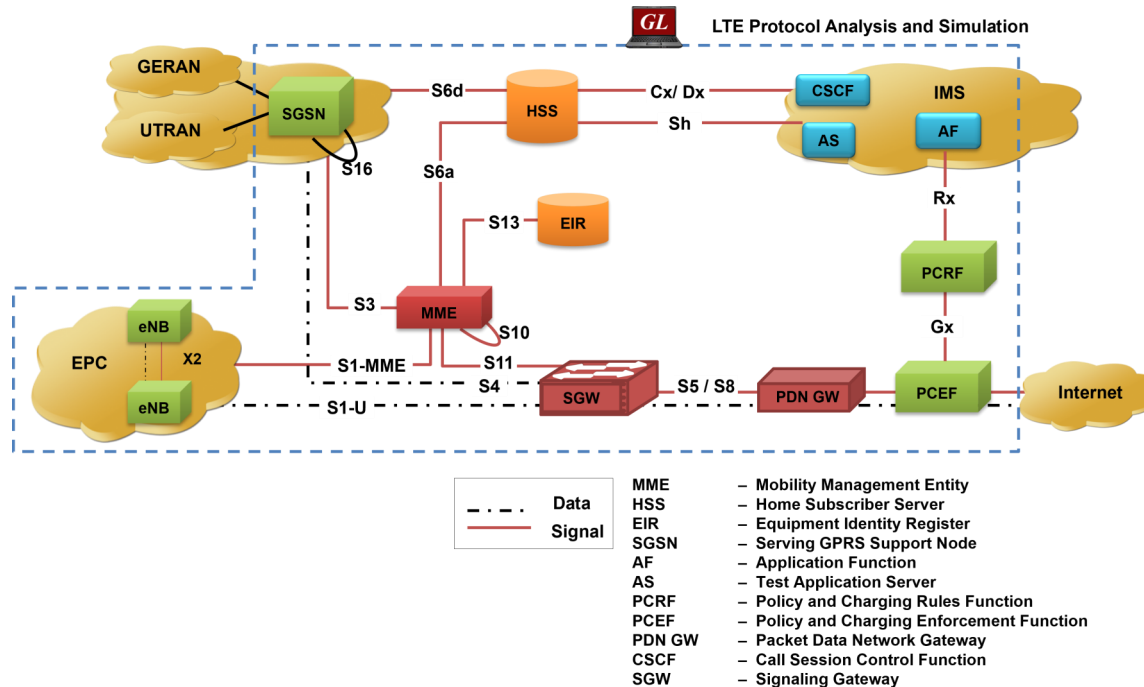

4G (LTE/VoLTE) Network Test Solutions



- End-to-End 4G LTE/IMS Communications Network Lab
- LTE/IMS Protocol Analysis
- LTE/IMS Network Monitoring Solutions
- Massive LTE/VoLTE UE and Traffic Simulation
- End-to-End Voice and Data Quality Testing on 4G/5G Networks
- LTE/IMS Protocol Emulation and Analysis

For more details, refer to [LTE-IMS Network Test Solution](#) webpage.

GL Communications Inc.

818 West Diamond Avenue - Third Floor, Gaithersburg, MD 20878
 Phone: (301) 670-4784 Fax: (301) 670-9187 Email: info@gl.com

4G (LTE/VoLTE) Communications Network Lab

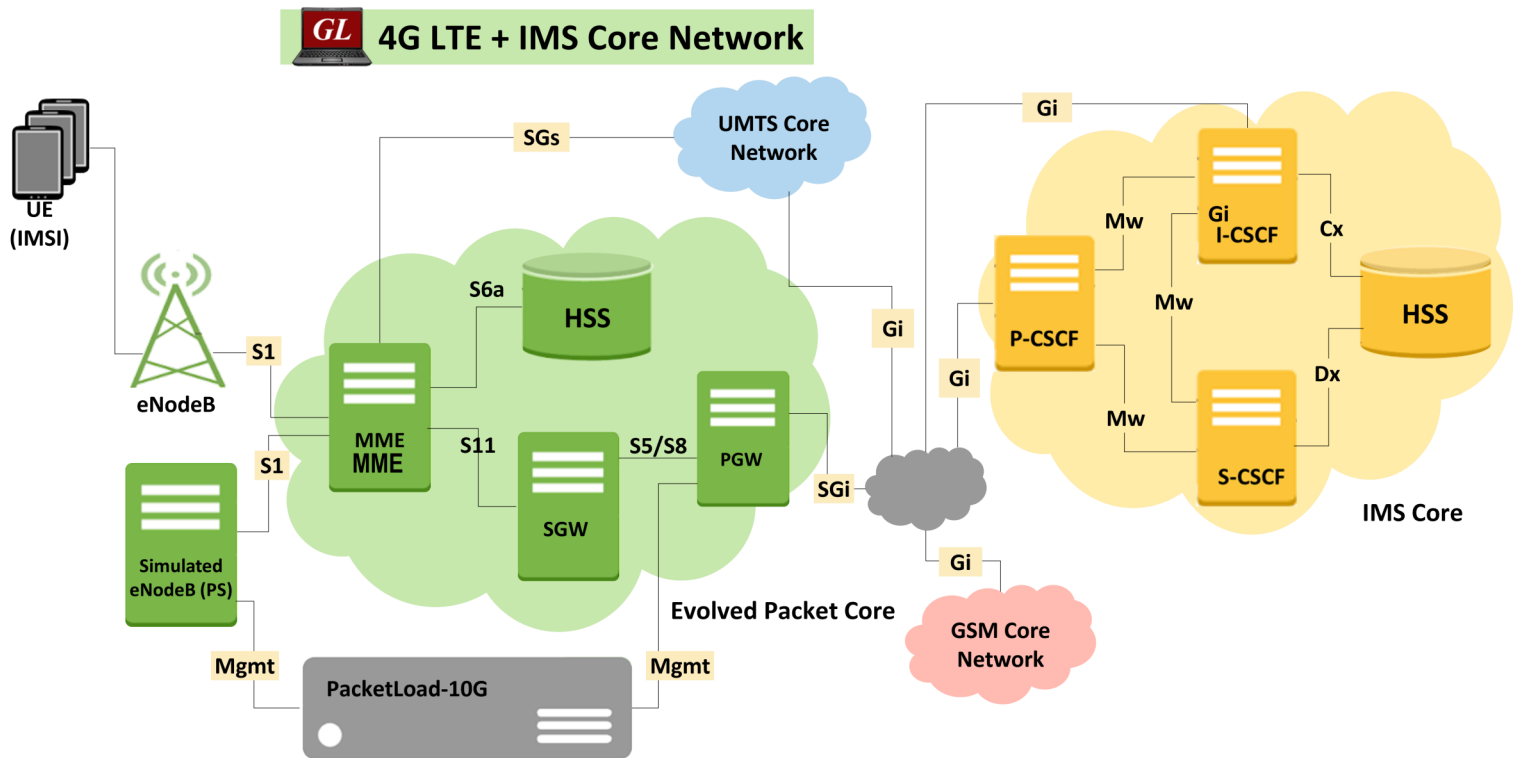

GL offers an end-to-end [4G LTE-IMS Communications Network Lab](#) (CNL) with all components within the wireless infrastructure to simulate both E-UTRAN, EPC (Evolved Packet Core) and IMS (IP Multimedia Subsystem), allowing complete testing of the LTE network. With these, one can simulate VoLTE calls in a lab environment, and study the network behaviour.

All functionalities conform to industry standards. The CNL provides reliable integrated solutions to vendors and service providers for simulation, monitoring, troubleshooting the 4G networks.

[MAPS™ LTE](#) supports emulation of multiple UEs and various interfaces of LTE (S1-u, S1-MME, X2, S3, S4, S5/S8, S6a, S10, S11, S13, S16). [MAPS™ LTE SLs](#) interface emulator supports UE based positioning method (A-GNSS) and necessary protocols in LTE [Location Service \(LCS\)](#) architecture for simulating network elements over SLs interface (E-SMLC and MME).

[MAPS™ IMS](#) supports simulating P-CSCF, I-CSCF, S-CSCF, PCRF, MGCF to test multiple interfaces in the IMS core network such as - Cx/Dx, Rx, Gx, Gm, Mw, SGi, Mi, and Mj. With the help of real mobile phones, and other simulated elements, the application allows for simulating real-time VoLTE calls and interworking of LTE-IMS with PSTN and VoIP networks.

[MAPS™ Diameter](#) can simulate S6a, S6d, Sh, 13, S13', SLg, SLh and Gy/Ro interfaces and test functionalities of network elements such as - MME, HSS, GMLC, AF, AS, PCRF, CSCF, SGSN, PCEF, EIR, PDN GW, CTF, and OCS.

Some of the real-time scenarios that can be realized with GL's 4G LTE-IMS Lab solution are listed below -

Voice, SMS

- Real-mobile <-> Real-mobile
- Simulated UE <->Real-mobile
- Simulated UE <->Simulated UE
- Real-mobile <-> Real-Mobile
- Voice/SMS Circuit-Switched Fall back (CSFB)
- Voice/SMS over IMS (VoLTE)
- Use of CAMEL for SMS and Prepaid Calls
- Streaming Online Video

Location Services

Inter-network and Intra-network Handovers

Web Browsing

- Real-mobile
- Simulated UE
- Bulk mobile traffic simulation using [PacketLoad™](#)

Inter-network Calls and Roaming Calls

- 4G user calling 2G user
- 4G user calling 3G user
- 4G user calling 3G roaming user
- 4G user calling 2G roaming user
- 2G user calling 4G roaming user
- 3G user calling 4G roaming user

LTE/VoLTE Network Monitoring & Diagnosis

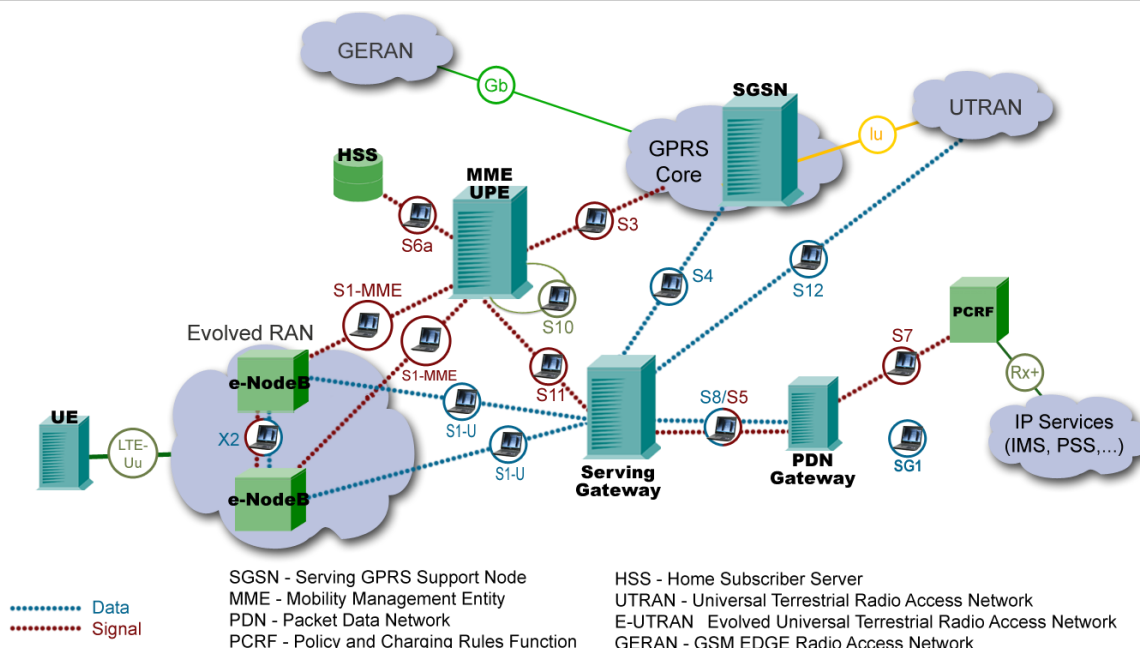

[PacketScan™ LTE](#) an All-IP Network Monitoring software offers powerful features to capture and monitor live signaling and traffic over IP (version 4 and 6).

Main features

- Capture, decode, segregate, and perform various measurements across various interfaces of the LTE-IMS networks
- Live monitoring of traffic statistics - digits, tones, voice, video, and T.38 fax over IPv4 and IPv6 (version 4 and version 6) networks
- Monitors QoS (quality of service) on voice and video calls
- Trace files for analysis can be loaded through simple command-line arguments

Following variants are available:

- As a Stand Alone Software for Real-Time Analysis (**PacketScan™**)
- As an Offline Analysis Tool (**PacketScan™**)
- High-Density Packet Monitoring Tool (**PacketScan™ HD**): [PacketScan™ HD](#) is a high density multi-protocol VoIP monitoring, reporting and diagnostic network monitoring appliance. It can capture and process high volumes of communication protocols over IP and Wireless at 1GigE (PKV120) and 10GigE (PKV122) data rates
- As a Probe with Central Monitoring—**NetSurveyorWeb™** (PKV170): Multiple PacketScan™ probes can be deployed along with a [centralized monitoring system](#). PacketScan™ can send Summary Fields, Frame Octets, and Call Detail Records to database along with Traffic Summary for the captured calls for detail analysis
- [NetSurveyorWeb™ Lite](#) (PKV169) is an integrated and a cost-effective web-based monitoring system that works with PacketScan™ probe as an add-on tool. It enhances the capabilities of PacketScan™ to process large volumes of real-time and historical data, filter for specific calls, build custom statistics and KPIs, and analyze the call detail records (CDRs)

Supported Protocols

LTE Interfaces

S1 Interface
 X2 Interface
 eGTP Interfaces
 S3 Interface
 S4 Interface
 S5/S8 Interface
 S10 Interface
 S11 Interface
 S16 Interface
 User-plane traffic (GTPv2-U)
 User-plane Gateway traffic

Location Services

SLs, SLg, SLh Interfaces

IMS and Diameter Interfaces

Cx/Dx Interface
 Gx Interface
 Rx Interface
 Gy/Ro Interface
 Mw, Mi, Mj, Mg Interface
 ISC Interface
 Gm Interface
 SGi Interface
 S6a Interface
 S13 and S13' Interface

LTE/VoLTE Network Monitoring & Diagnosis

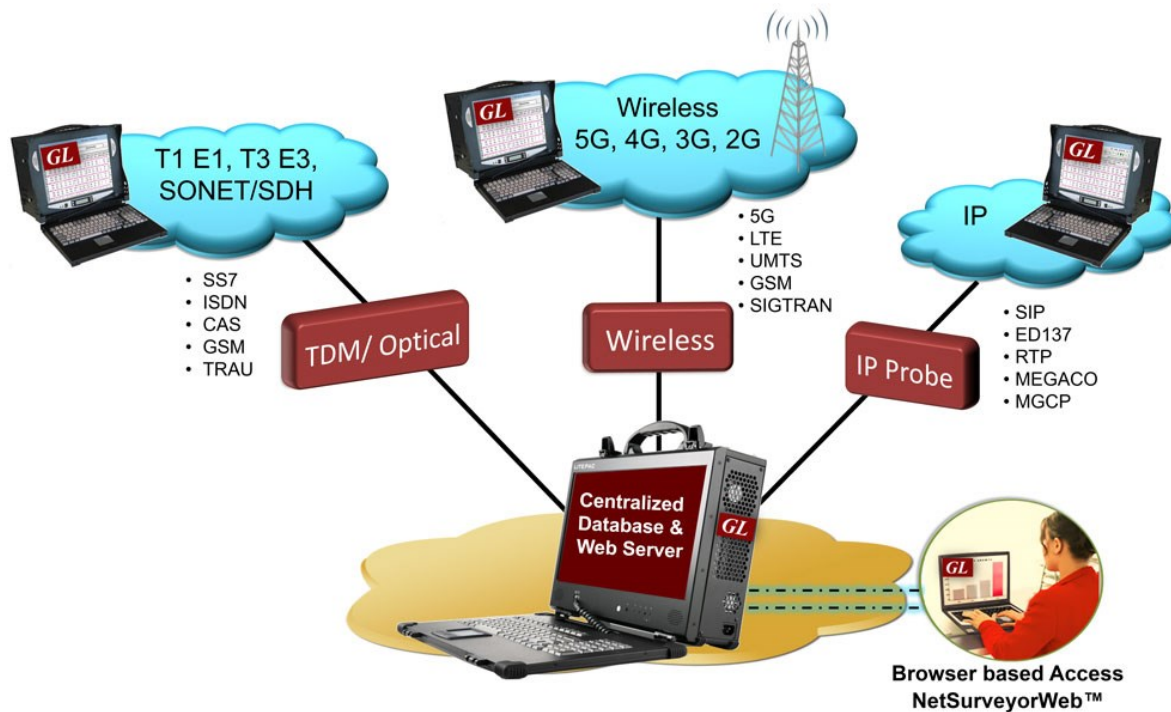

NetSurveyorWeb™

GL's [NetSurveyorWeb™ \(PKV170\)](#) is a centralized web-based client that facilitates display of call data records and call summary using a web interface based on a scalable and flexible architecture. It is used in conjunction with GL's LTE Protocol Analyzer and IMS Protocol Analyzer probes to non-intrusively monitor the entire network from a central remote testing location.

GL's [LTE-IMS Protocol Analyzers](#) have unlimited ability to capture, decode, and measure KPIs. The analyzers support decoding all LTE-Diameter-IMS protocols, as listed in the table here. GL's LTE-IMS protocol analysis probes feed data to centralized database (Oracle) in real-time for further analysis. The probes provide instant visibility into the performance with extensive KPIs, and also the operation of nodes in LTE networks.

NetSurveyorWeb™ Lite

[NetSurveyorWeb™ Lite \(PKV169\)](#) is an integrated and a cost-effective monitoring system that works at the probe-level as an add-on tool with all real-time Protocol Analyzers. It is a web-based client that allows to view historical and real-time call data records. It enhances the capabilities of protocol analyzer to process large volumes of calls, filter for specific calls, build custom statistics and KPIs, automation and graphical features to analyze the call detail records (CDRs).

Supported Protocols

LTE Interfaces

S1 Interface
X2 Interface
eGTP Interfaces
S3 Interface
S4 Interface
S5/S8 Interface
S10 Interface
S11 Interface
S16 Interface
User-plane traffic (GTPv2-U)
User-plane Gateway traffic

Location Services

SLs, SLg, SLh Interfaces

IMS and Diameter Interfaces

Cx/Dx Interface
Gx Interface
Rx Interface
Gy/Ro Interface
Mw, Mi, Mj, Mg Interface
ISC Interface
Gm Interface
SGi Interface
S6a Interface
S13 and S13' Interface

Massive LTE/VoLTE UE and Traffic Simulation

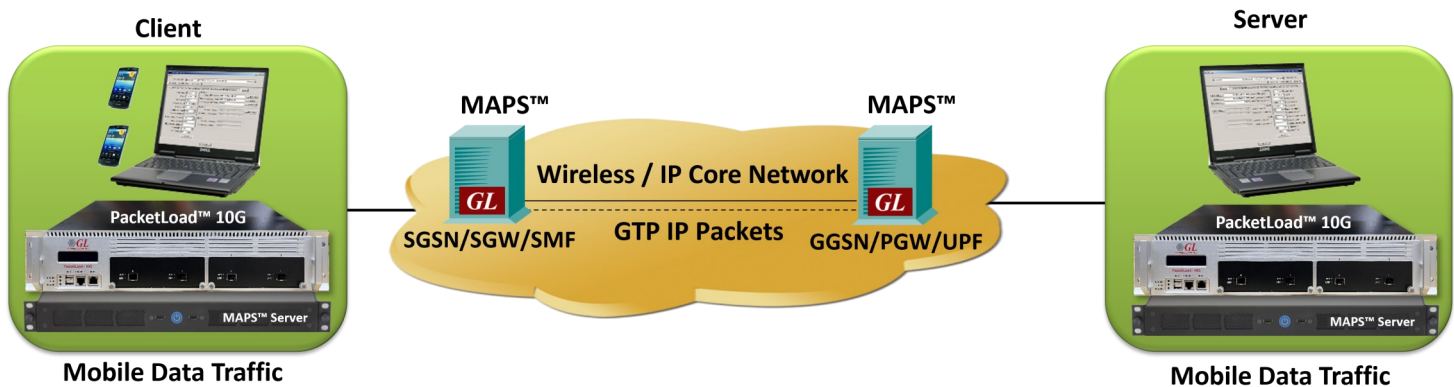

GL's [MAPS™ Server with PacketLoad™](#) appliance supports massive simulation of UEs (up to 100000) with mobile data traffic at very high speed rates (up to 4 Gbps or 40 Gbps) for both UMTS, and LTE networks.

It offers all features to perform functional unit tests at every integration point within the wireless infrastructure. The MAPS™ Server with PacketLoad™ can be used to test all network elements in access and packet core to ensure negotiated QoS is met.

The solution allows to encapsulate the generated packet data within GTP headers and transmit through the gateway points such as SGSN & GGSN, or SGW & PGW. It allows simultaneous simulation of multiple sessions per user to verify bearer allocation bandwidth at the end points. Currently, the solution offers stateful TCP/HTTP, and PCAP Replay traffic types. PacketLoad™ supports HTTP traffic simulation with the base requirements such as port number, server IP address, and pre-canned HTTP traffic file.

The solution also supports [Mobile IP traffic](#) (ETH101) and [Mobile Gateway Traffic](#) (ETH102) types of traffic simulation. These modules also support generation and verification of Web (HTTP) data traffic.

Massive 4G (LTE/IMS) UE supports -

- **End-to-End testing:** MAPS™ eNodeB simulator allows to simulate massive number of UEs (more than 100,000) with the packet data traffic encapsulated within GTP headers. The generated packet data is transmitted through the SGW & PGW gateway points. At the receiving end, MAPS™ Server with Packet Load is used to verify the received data with the various statistics such as Total packets transmitted and received, Latency, Delay, Bandwidth per port, Total TCP connections created, Successful connections, Packet loss, etc.
- **Single Interface Testing:** Simulated eNode +MME (MAPS™ LTE S1), PGW (MAPS™ LTE eGTP) along with the PacketLoad™ appliance can function together to test customer's SGW (DUT) operation at full load under various traffic conditions, and thus perform comprehensive load testing

End-to-End 4G (LTE/VoLTE), 5G Network Testing

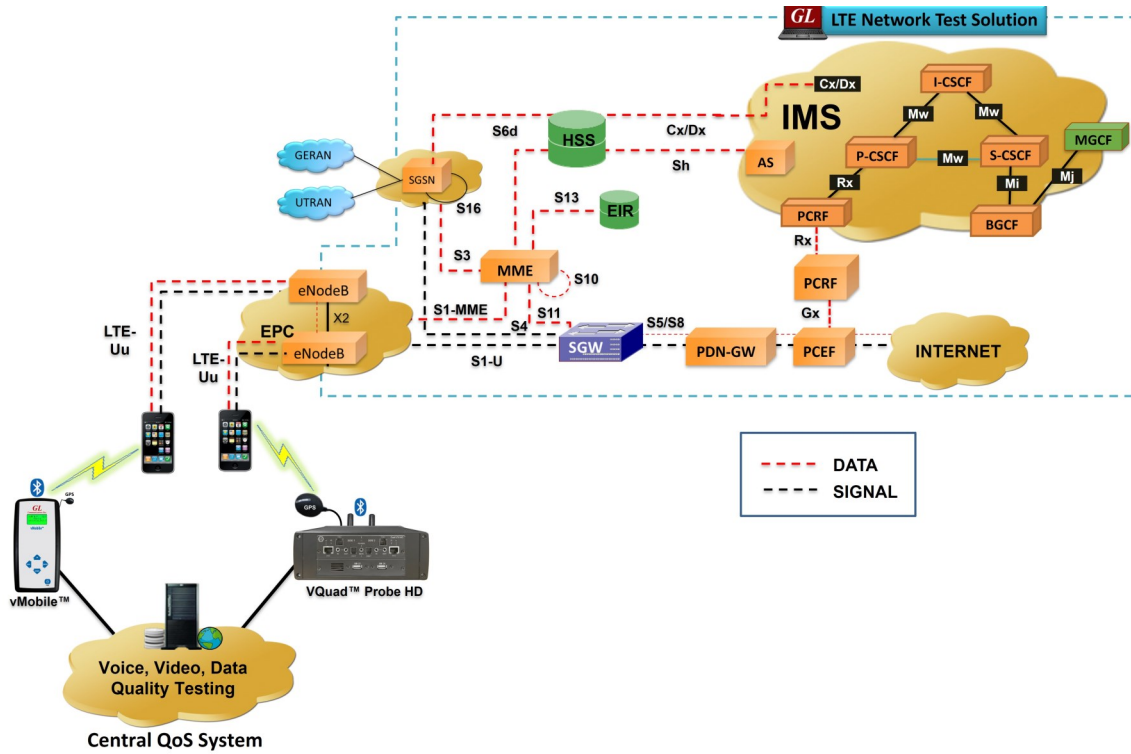

4G (LTE/VoLTE), 5G QoS Test Suite Voice, Video, & Data Quality Testing

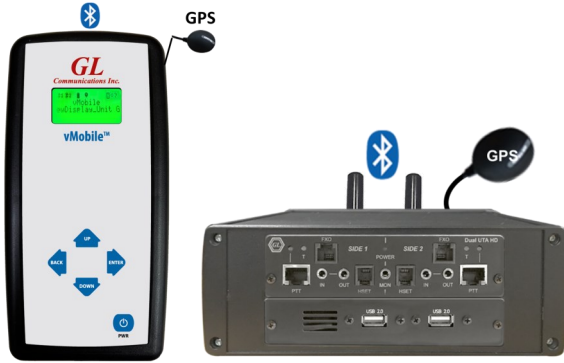

vMobile™ and VQuad™ Probe HD

Supports NB, WB



Dual UTA HD

[vMobile™](#) is a handheld ultra-portable device that brings true mobility to voice and data quality testing for any mobile phone and any mobile radio, changing the way automated drive and walk testing is performed. The vMobile™ is simple to setup and operate for running these tests in order to benchmark both mobile phone networks and mobile radio networks.

[VQuad™ Probe HD](#) is a self-contained unit used to objectively evaluate Signal Strength, Voice, Video, and Data Quality on Cellular networks (5G, 4G VoLTE, 3G, 2G), Land Mobile Radios, and Wired networks.

It includes VQuad™ software, [Dual Universal Telephone Adapter](#) (Dual UTA HD), and PC in a portable platform. VQuad™ Probe HD can connect to practically any end-point, wired or wireless devices, independent of underlying network type. VoLTE testing supported using either Bluetooth® or wired headset connection methods.

LTE-IMS Protocol Emulation

MAPS™ IMS Emulator

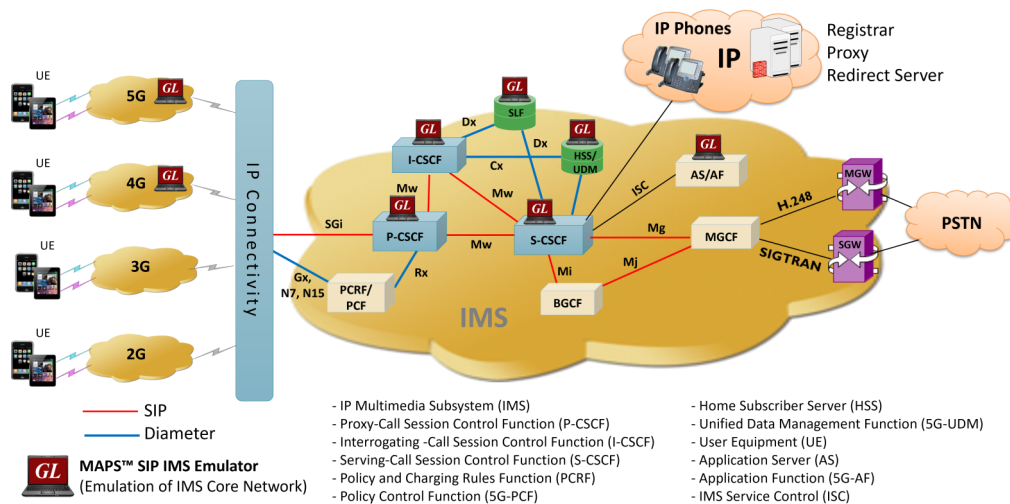

[MAPS™ IMS](#), is built on Session Initiation Protocol (SIP) as the base to further support packaging of voice, video, data, fixed, and mobile services on a single platform to end users.

GL's **MAPS™ SIP IMS** test suite provide an advanced full-fledged network environment that enables user to test their applications, devices, and services prior to deployment on a real-time network. It can be used to

simulate all or specific elements within IMS network, such as P-CSCF, I-CSCF, S-CSCF, PCRF, MGCF which provides the IMS core network, it also supports simulation of all the nodes to achieve an end-to-end call simulation over LTE - IMS network. A Voice over LTE call can happen within the same network or between 2 different service providers.

MAPS™ IMS Multi Interface emulator is designed to simulate end-to-end Online and Offline charging procedures, interacting with SIP (UEs) and Diameter (OCS, OFCS) interfaces.

MAPS™ SIP IMS Emulator includes ready-to-use scripts, as per IETF specification, and test cases to verify conformance of actions such as registration, call control, proxies and other servers. Test scripts include general messaging and call flow scenarios for multimedia call session setup and control over IP networks.

MAPS™ LTE-S1 Emulator (S1 MME interface)

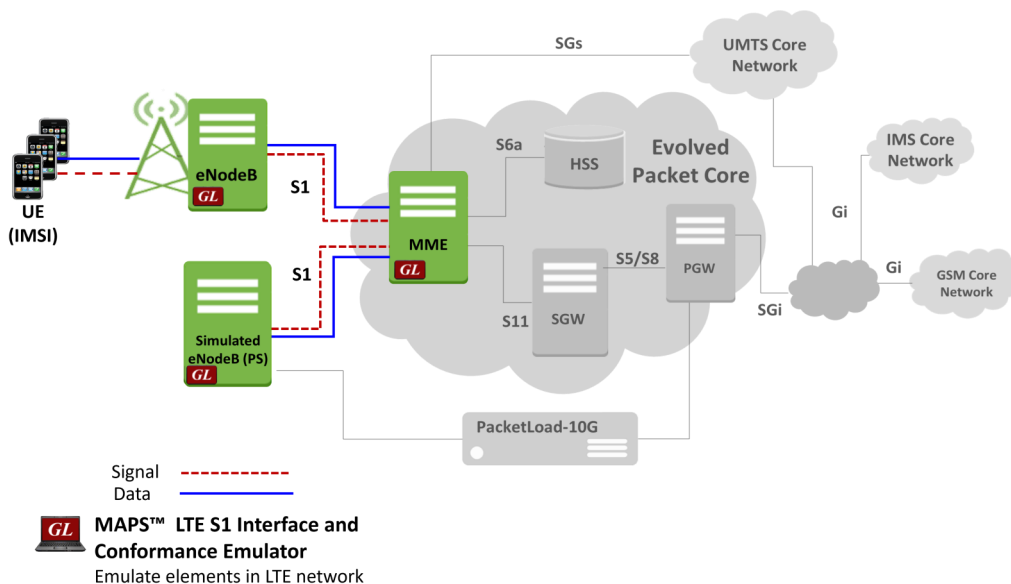

GL's MAPS™ designed for testing [LTE - S1 interface](#) can simulate Evolved Node B (eNodeB), and Mobility Management Entity (MME) network elements. The application gives the users the unlimited ability to edit S1-AP/NAS messages and call scenarios (message sequences). "Message sequences" are generated through scripts. "Messages" are created using message templates.

The product supports real-time GTP traffic using Mobile traffic core - GTP (ETH101) between any two nodes in LTE and UMTS networks.

It also supports Mobile Traffic Core - Gateway (ETH102) module to offload GTP traffic to media gateway over IP. These modules also support generation and verification of data traffic such as Email, FTP, Web (HTTP), Video, and more.

LTE-IMS Protocol Emulation

MAPS™ LTE X2-AP Emulator

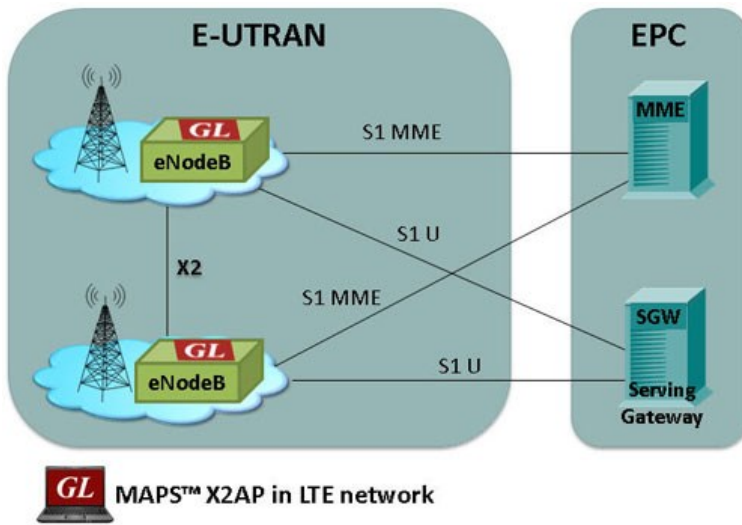

The [X2 Application Protocol \(AP\)](#) is the interconnecting interface between two eNodeBs in LTE network and supports both Control Plane and User Plane. GL's MAPS™ LTE X2AP is used to co-ordinate handovers and perform load management between Evolved NodeBs (eNodeBs) - Source eNodeB and Target eNodeB. The MAPS™ X2-AP test tool is designed with specific test cases, as per LTE 3GPP TS 36423-900 standards.

LTE X2 AP simulates thousands of UEs and supports Mobility Management, Load Management, Error Situations, Re-setting X2, Setting up the X2, and eNodeB Configuration Update procedures.

The product also supports Mobile traffic simulation (ETH100, ETH101, ETH102) between any two user-plane nodes in LTE network.

MAPS™ LTE Diameter Emulator

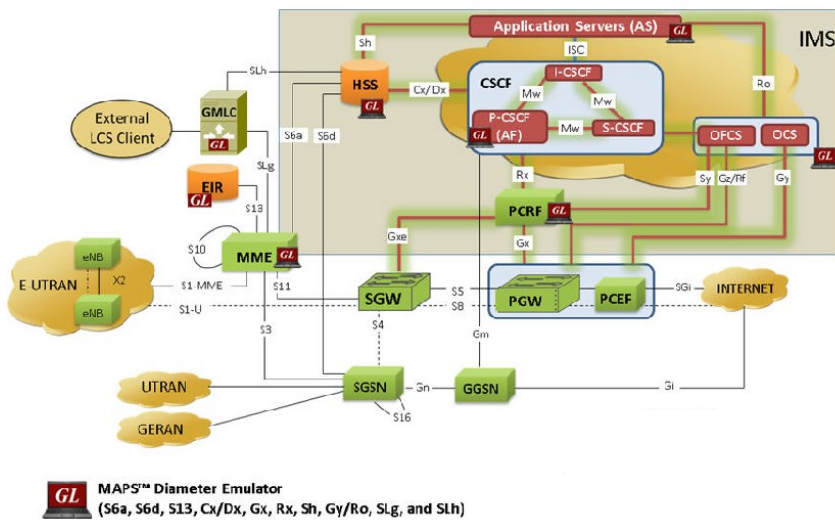

[MAPS™ Diameter](#) is an ideal solution for emulation of various interfaces and elements in the LTE core network such as the MME, SGSN, HSS, PCRF, CSCF, PCEF, EIR, AF, AS, CTF, OCS, and PSCF nodes in S6a, S6d, S13, Cx/Dx, Gx, Rx, Sh, Gy, SLh, and SLg interfaces designed as per 3GPP standards.

MAPS™ Diameter is enhanced to simulate Location Service (LCS) based SLh and SLg interfaces between the GMLC <-> HSS and GMLC <-> MME defined for the Control Plane as per 3GPP TS 23.271 specifications.

The product supports various procedures over listed

interfaces, including-

- **S6a interface** - Location Management, Subscriber Data Handling, Authentication, Fault Recovery, and Notification procedures
- **Rx interface** - AA-Request/Answer, Re-Auth-Request/Answer, Abort-Session-Request/Answer, and Session-Termination-Request/Answer procedure
- **S13 and S13' interfaces** - Mobile Equipment Identity Check procedure
- **Gx interface** - IPCAN Session Establishment and Modification
- **SLg and SLh interfaces** - Emergency Location Request/Response, and Repeated Location Report
- **Gy interface** - Immediate Event Charging, CC-Request/Answer, Re-Auth-Request/Answer Procedures

LTE-IMS Protocol Emulation

MAPS™ LTE eGTP-c Emulator (S3, S4, S5, S8, S10, S11 & S16 interfaces)

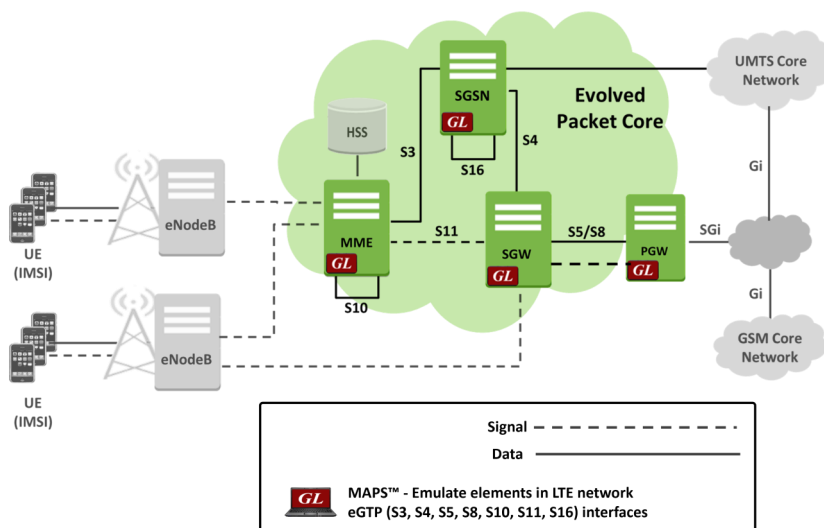

GL's MAPS™ designed for testing [LTE eGTP interfaces](#) - S3, S4, S5/S8, S10, S11, & S16 can simulate Mobility Management Entity (MME), Serving Gateway (SGW), and Packet Data Network Gateway (PGW) network elements. The MAPS™ LTE eGTP supports simulation of Path Management procedures, Tunnel Management procedures, Control Plane, and User-plane GTP traffic simulation over eGTP interfaces.

The product supports simulation of user-plane packet (GTPv2-U) traffic in LTE network using Mobile traffic core - GTP (ETH101) between any two nodes in LTE and UMTS networks, it also supports in verifying the BERT, and HTTP traffic generation capability.

It also supports Mobile Traffic Core - Gateway (ETH102) module to offload GTP traffic to media gateway over IP. These modules also support generation and verification of data traffic such as Web (HTTP).

Simulation of SMS and CS Fallback

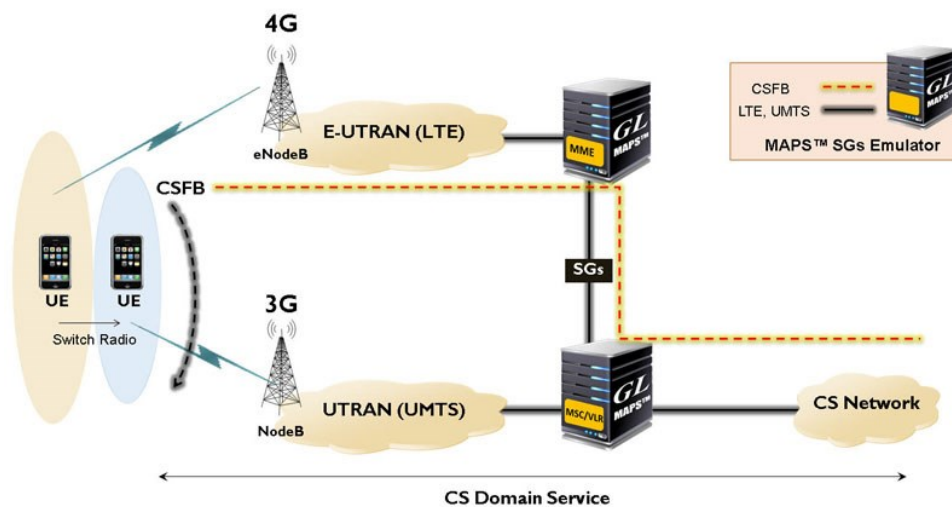

With CSFB (Circuit-switched Fall Back) feature, an LTE device "falls back" to the 3G or 2G network to complete the call or to deliver Voice and SMS.

GL's [MAPS™ SGs](#) is designed to simulate the CS fallback function for Voice and SMS delivery via the Circuit Switched (CS) core network using SGs interface between the MME in the EPS and the VLR, as per 3GPP specifications.

The SGs Application Part (SGsAP) protocol used on the SGs interface between the MME <-> MSC/VLR allows location management coordination and relay certain messages related

to GSM circuit switched services over the EPS system.

In addition, MAPS™ IMS emulators can emulate functions of an IP-SM-GW network element in order to push or pull SMS from LTE-EPC to SMSC over IP/IMS network. In SMS over IMS communication, SMS is encapsulated in a SIP message and carried over IMS core network to SMSC. The IP Short Messaging Gateway (IP-SM-GW) network element provides the interconnection between GSM-UMTS network and LTE-EPC network for sending and receiving SMSes.