

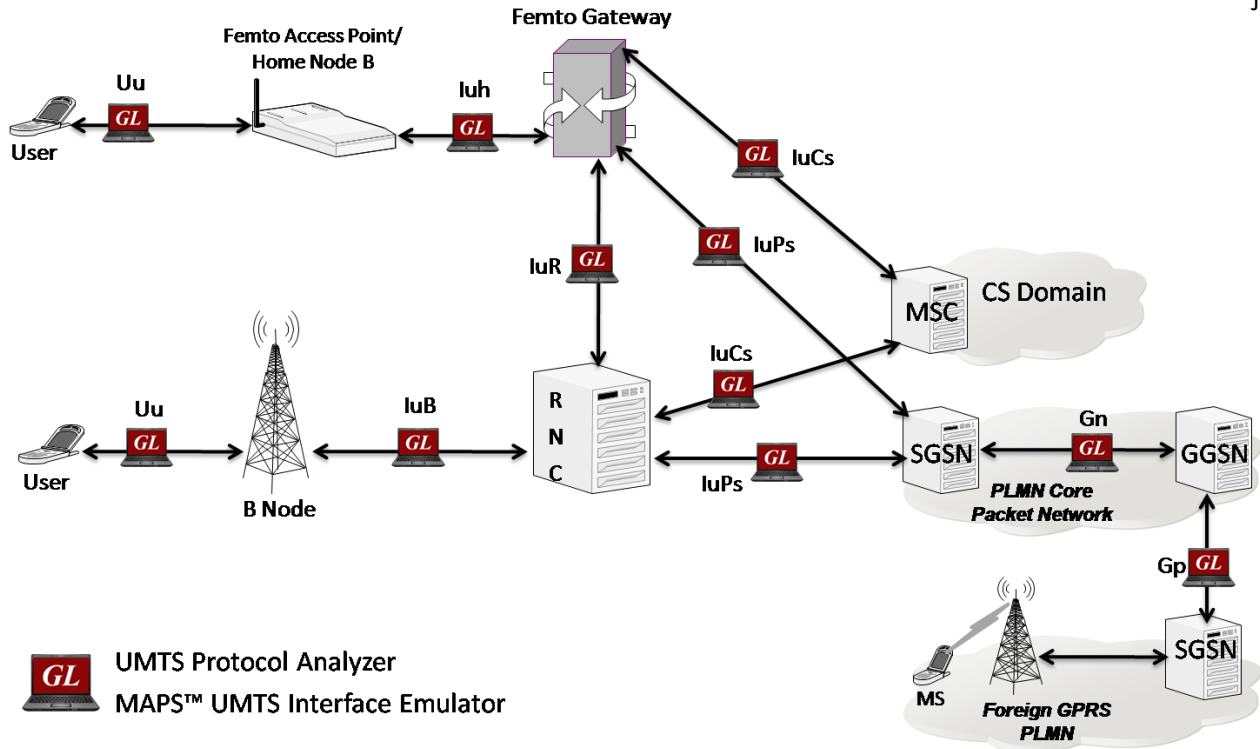

3G Network Test Solutions

(UMTS, GPRS Networks)

January 2024



- End-to-End 3G Communications Network Lab
- UMTS/ GPRS Protocol Analysis
- UMTS, GPRS Network Monitoring Solutions over TDM & IP
- Massive UE and Traffic Emulation in UMTS Network
- Automated Voice, Data & Video Quality Testing
- UMTS/ GPRS Protocol Emulation

For more details, refer to [UMTS Protocol Test Suite](#) webpage.

GL Communications Inc.

818 West Diamond Avenue - Third Floor, Gaithersburg, MD 20878
 Phone: (301) 670-4784 Fax: (301) 670-9187 Email: info@gl.com

3G UMTS-GPRS Communications Network Lab

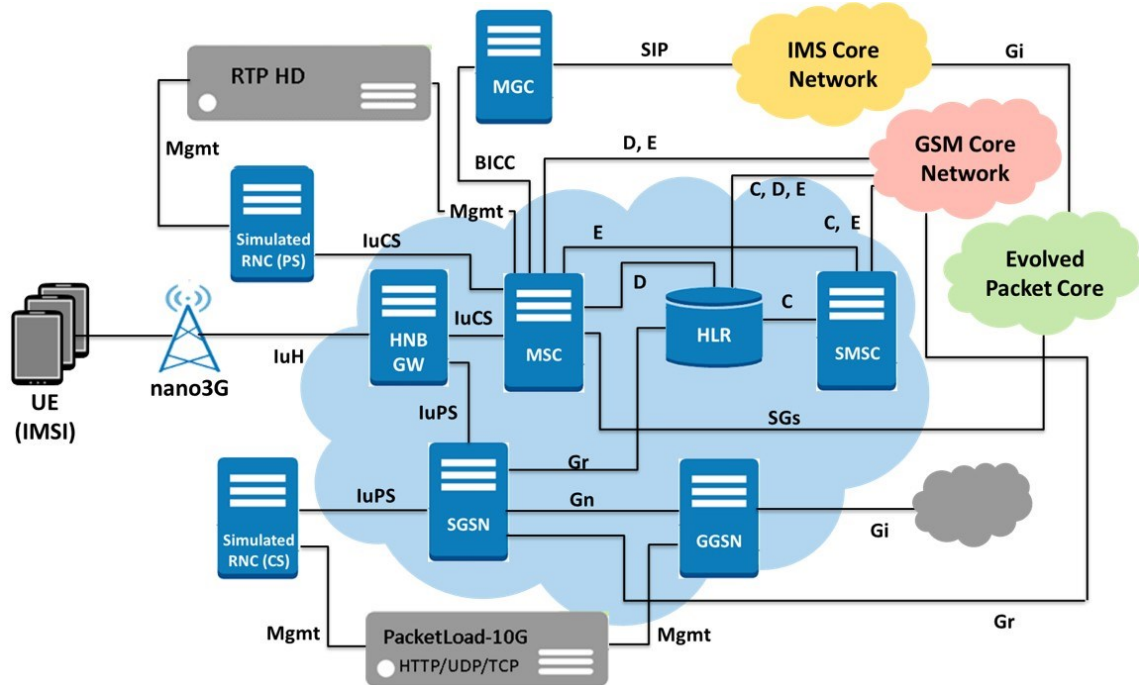

GL offers an end-to-end [3G UMTS GPRS Communications Network Lab \(CNL\)](#) with all components within the wireless infrastructure to emulate UTRAN, and UMTS Core elements, allowing complete testing of the UMTS network. With these, one can emulate both circuit-switched voice/sms and packet-switched data traffic in a lab environment, and study the network behaviour. All functionalities conform to industry standards. The CNL provides reliable integrated solutions to vendors and service providers for emulation, monitoring, troubleshooting the 3G network.

[MAPS™ UMTS](#) supports emulation of multiple UEs and various interfaces of UMTS (luCS, luH, luPS, C, D, E, Gr, Gn, Gp, Gb). [MAPS™ UMTS Lg, Lh, luPC](#) interface emulator supports UE based positioning method (A-GNSS) and necessary protocols in UMTS [Location Service \(LCS\)](#) architecture for emulating network elements over Lg (MSC/VLR, SGSN, GMLC), Lh (HLR, GMLC), luPC (SAS and RNC) interfaces.

[MAPS™ GPRS Gb](#) supports emulating BSS (Base Station Subsystem) and the SGSN (Serving GPRS Support Node) network elements over IP. MAPS™ GPRS Gb also supports SGSN Pooling feature to test and verify redundancy, load balancing, and scalability of network. SGSN pooling solution overcomes the restriction of a BSC node connecting to just one SGSN.

[MAPS™ Gn Gp](#) can emulate GTP messages and signaling specification as defined in 3GPP TS 29.060 GPRS Tunneling Protocol (GTP) standard. **MAPS™ GnGp Server with PacketLoad™** appliance supports massive emulation of UEs (up to 100000) with high-volume user-plane mobile data traffic emulation (up to 40 Gbps) for UMTS networks.

Some of the real-time scenarios that can be realized with GL's 3G UMTS GPRS Lab solution are listed below -

Voice, SMS (CS)

- Real-mobile <-> Real-mobile
- Simulated UE <->Real-mobile
- Simulated UE <->Simulated UE
- Real-mobile <-> Real-Mobile
- Bulk voice traffic emulation using [MAPS™ RTP HD](#)
- Voice/SMS Circuit-Switched Fall back (CSFB)

Location Services

Web Browsing

- Real-mobile
- Simulated UE
- Bulk mobile traffic emulation using [PacketLoad™](#)

Inter-network Calls and Roaming Calls

- 3G user calling 2G user
- 3G user calling 4G user
- 3G user calling 4G roaming user
- 3G user calling 2G roaming user
- 2G user calling 3G roaming user
- 4G user calling 3G roaming user

3G UMTS-GPRS Network Monitoring & Diagnosis

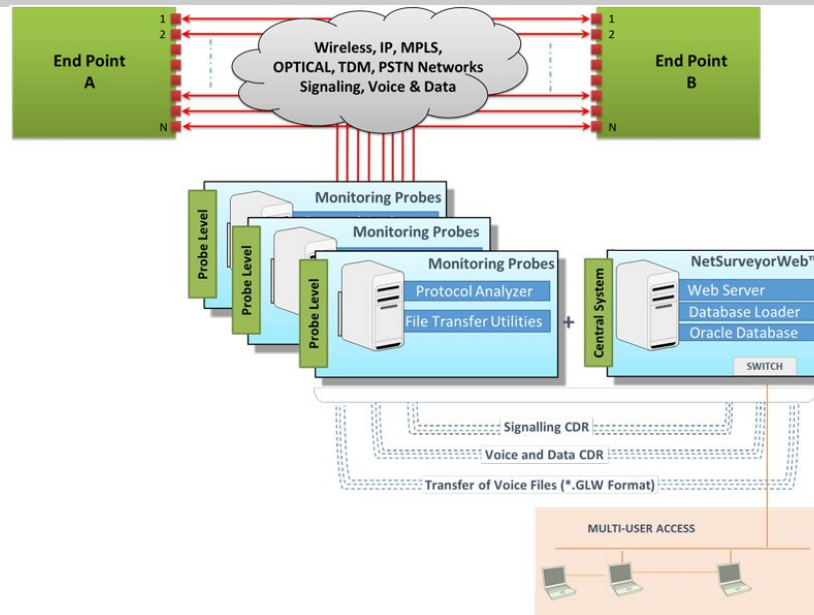

[PacketScan™ UMTS](#) an All-IP Network Monitoring software offers powerful features to capture and monitor live signaling and traffic over IP (version 4 and 6).

Main features

- Capture, decode, segregate, and perform various measurements across various interfaces of the UMTS GPRS networks
- Live monitoring of traffic statistics - digits, tones, voice, video, and T.38 fax over IPv4 and IPv6 (version 4 and version 6) networks
- Monitors QoS (quality of service) on voice and video calls
- Trace files for analysis can be loaded through simple command-line arguments

Following variants are available:

- As a stand-alone software for Real-Time Analysis (**PacketScan™**)
- As an Offline Analysis Tool (**PacketScan™**)
- High-Density Packet Monitoring Tool (**PacketScan™ HD**): [PacketScan™ HD](#) is an high density multi-protocol VoIP monitoring, reporting and diagnostic network monitoring appliance
- As a Probe with Central Monitoring—**NetSurveyorWeb™** (PKV170): Multiple PacketScan™ probes can be deployed along with a [centralized monitoring system](#). PacketScan™ can send Summary Fields, Frame Octets, and Call Detail Records to database along with Traffic Summary for the captured calls for detail analysis
- [NetSurveyorWeb™ Lite](#) (PKV169) is an integrated and a cost-effective web-based monitoring system that works with PacketScan™ probe as an add-on tool. It enhances the capabilities of PacketScan™ to process large volumes of real-time and historical data, filter for specific calls, build custom statistics and KPIs, and analyze the call detail records (CDRs)

Supported Protocols

UMTS Interfaces

Circuit Switched -luCS, luH
Packet-switched-Gc, Gr, Gf,
Gd, luPS, Gn Gp, Gi
MAP Interfaces-B, C, D, E, F,
H
Inter-network Interfaces -
BICC, CAP, INAP

Location Services

Lg, Lh Interfaces
luPC Interface

Nodes

NodeB
HNB
HNBGW
RNC
MSC
HLR
SGSN
GGSN
GMLC
SAS

3G UMTS-GPRS Network Monitoring & Diagnosis

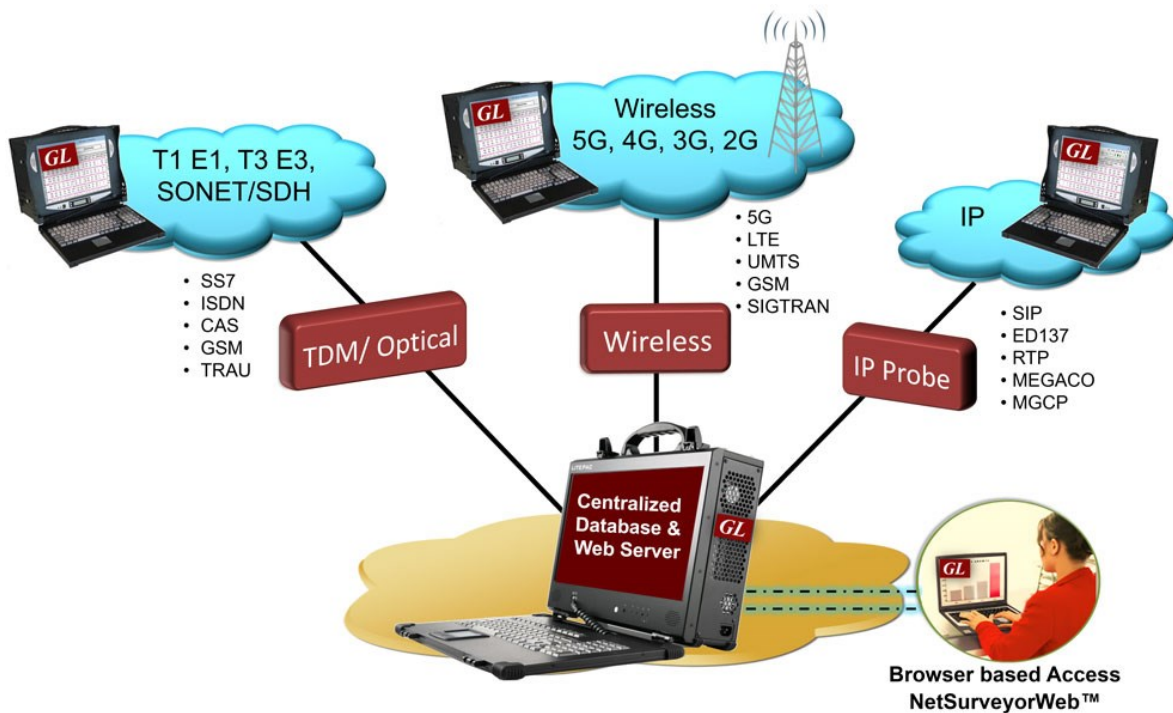

NetSurveyorWeb™

GL's [NetSurveyorWeb™ \(PKV170\)](#) is a centralized web-based client that facilitates display of call data records and call summary using a web interface based on a scalable and flexible architecture. It is used in conjunction with GL's UMTS Protocol Analyzer and GPRS Protocol Analyzer probes to non-intrusively monitor the entire network from a central remote testing location.

GL's [LTE-IMS Protocol Analyzers](#) have unlimited ability to capture, decode, and measure KPIs. The analyzers support decoding all UMTS-GPRS protocols, as listed in the table here. GL's UMTS-GPRS protocol analysis probes feed data to centralized database (Oracle) in real-time for further analysis. The probes provide instant visibility into the performance with extensive KPIs, and also the operation of nodes in UMTS network.

NetSurveyorWeb™ Lite

[NetSurveyorWeb™ Lite \(PKV169\)](#) is an integrated and a cost-effective monitoring system that works at the probe-level as an add-on tool with all real-time Protocol Analyzers. It is a web-based client that allows to view historical and real-time call data records. It enhances the capabilities of protocol analyzer to process large volumes of calls, filter for specific calls, build custom statistics and KPIs, automation and graphical features to analyze the call detail records (CDRs).

Supported Protocols

UMTS Interfaces

Circuit Switched -IuCS, IuH
Packet-switched-Gc, Gr, Gf, Gd,
IuPS, Gn Gp, Gi
MAP Interfaces-B, C, D, E, F, H
Inter-network Interfaces -BICC,
CAP, INAP

Location Services

Lg, Lh Interfaces
IuPC Interface

Nodes

NodeB
HNB
HNBGW
RNC
MSC
HLR
SGSN
GGSN
GMLC
SAS

Massive UMTS UE and Mobile Traffic Emulation

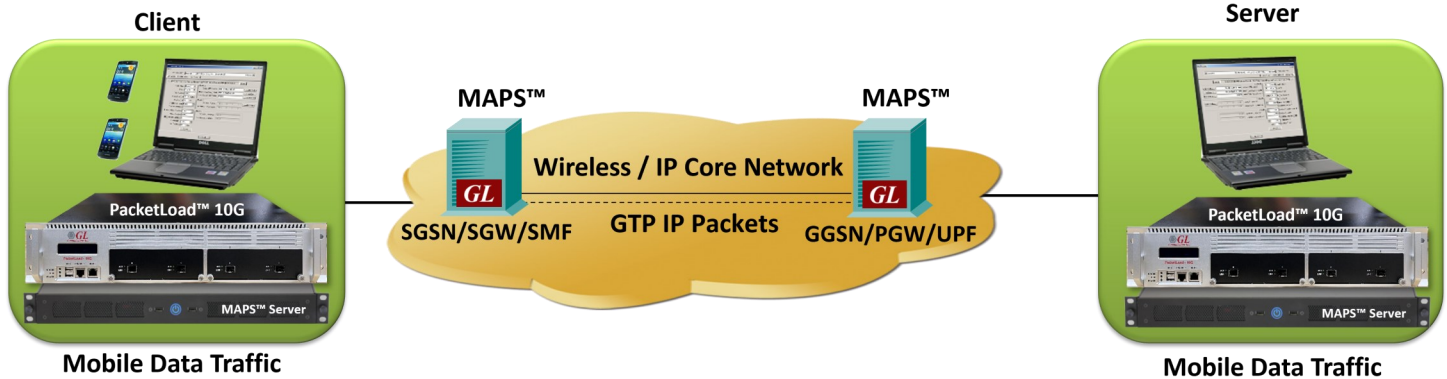

GL's [MAPS™ Server with PacketLoad](#) appliance supports massive emulation of UEs (up to 100000) with mobile data traffic at very high speed rates (up to 4 Gbps or 40 Gbps) for both UMTS, and LTE networks.

It offers all features to perform functional unit tests at every integration point within the wireless infrastructure. The MAPS™ Server with PacketLoad™ can be used to test all network elements in access and packet core to ensure negotiated QoS is met.

The solution allows to encapsulate the generated packet data within GTP headers and transmit through the gateway points such as SGSN & GGSN, or SGW & PGW. It allows simultaneous emulation of multiple sessions per user to verify bearer allocation bandwidth at the end points. Currently, the solution offers stateful TCP/HTTP, and PCAP Replay traffic types. PacketLoad™ supports HTTP traffic simulation with the base requirements such as port number, server IP address, and pre-canned HTTP traffic file.

The solution also supports [Mobile IP traffic](#) (ETH101) and [Mobile Gateway Traffic](#) (ETH102) types of traffic simulation. These modules also support generation and verification of Web (HTTP) data traffic.

Massive 3G UMTS UE supports -

- End-to-End testing:** MAPS™ RNC simulator allows to simulate massive number of UEs (more than 100,000) with the packet data traffic encapsulated within GTP headers. The generated packet data is transmitted through the SGSN & GGSN gateway points. At the receiving end, MAPS™ Server with Packet Load is used to verify the received data with the various statistics such as Total packets transmitted and received, Latency, Delay, Bandwidth per port, Total TCP connections created, Successful connections, Packet loss, etc.

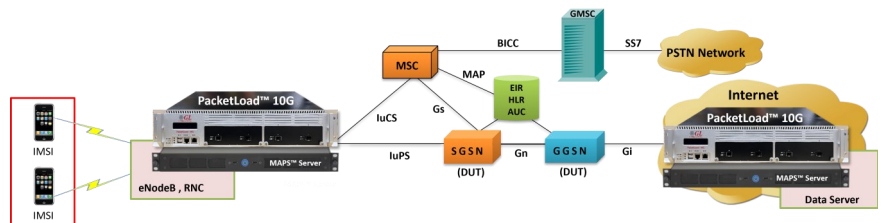

- Single Interface Testing:** Simulated RNC (MAPS™ IuPS), GGSN (MAPS™ GnGp) along with the PacketLoad appliance can function together to test customer's SGSN (DUT) operation at full load under various traffic conditions, and thus perform comprehensive load testing

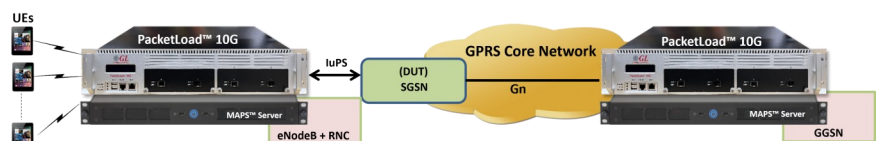

End-to-End UMTS-GPRS Network Testing

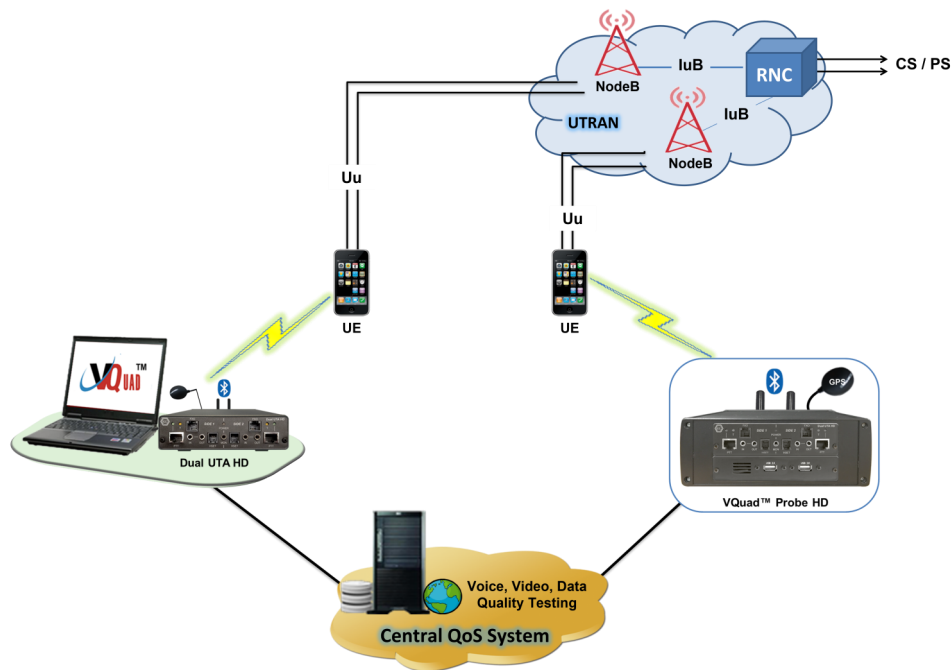

UMTS GPRS QoS Test Suite Automated Voice, Data & Video Quality Testing

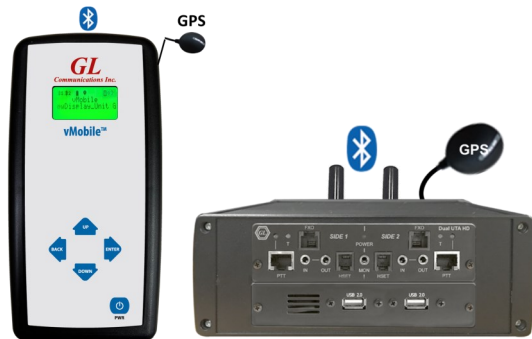

vMobile™ and VQuad™ Probe HD

Supports NB, WB



Dual UTA HD unit

[vMobile™](#) is a handheld ultra-portable device that brings true mobility to voice and data quality testing for any mobile phone and any mobile radio, changing the way automated drive and walk testing is performed. The vMobile™ is simple to setup and operate for running these tests in order to benchmark both mobile phone networks and mobile radio networks.

[VQuad™ Probe HD](#) is a self-contained unit used to objectively evaluate Signal Strength, Voice, Video, & Data Quality on Cellular networks (5G, 4G VoLTE, 3G, 2G), Land Mobile Radios, and Wired networks. It includes VQuad™ software, Dual Universal Telephone Adapter (Dual UTA HD), and PC in a portable platform.

VQuad™ Probe HD can connect to practically any end-point, wired or wireless devices, independent of underlying network type. 3G/4G testing supported using either Bluetooth® or wired headset connection methods.

Various associated analytical applications (Voice Quality, Video Quality, Data tests, Echo and Delay tests, Fax tests, Voice Band Analysis) work with the base VQuad™ software to provide "end-to-end assessment" of the network performance.

GL's Voice Quality Testing (VQT) supports automated voice quality between using - POLQA (ITU-P.863) and PESQ (ITU-P.862). The POLQA algorithm is specifically used for testing Wideband 3G/4G networks. GL's VQuad™ NetTest solution supports egress/ingress Data analysis along with Voice/Video Quality Testing and GPS.

UMTS-GPRS Protocol Emulation

MAPS™ GPRS Gb Interface Emulator

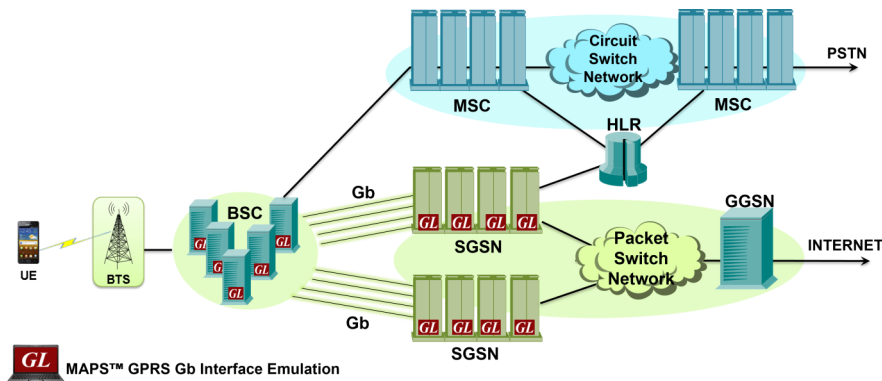

[MAPS™ GPRS Gb Interface Emulator](#) supports simulation of BSS (Base Station Subsystem) and the SGSN (Serving GPRS Support Node) network elements over IP transmission protocol. MAPS™ GPRS Gb also supports **SGSN Pooling** feature to test and verify redundancy, load balancing, and scalability of network. SGSN pooling solution overcomes the restriction of a BSC node connecting to just one SGSN. It introduces a new routing mechanism which allows a BSC belonging to an SGSN Pool, connect to all SGSNs

in that pool. This permits a mobile station to roam freely without a need to change the serving SGSN.

- Simulates SGSN (Serving GPRS Support Node) and BSS (Base Station Subsystem) elements in GPRS Gb interface
- Generates hundreds of Control Signaling (Load Testing)
- Generates and processes NS (Network Service), BSSGP (Base Station Subsystem GPRS Protocol), and various GPRS session procedure messages
- Supports Gb interface procedures including Network Service Control, Identity Check, Combined GPRS/IMSI Attach, and Routing Area Update
- Mobile Traffic Simulation allows transmission of pre-canned HTTP file (*.txt), multiplexes both signaling and traffic over Gb interface

MAPS™ UMTS Gn Gp Emulator (over IP)

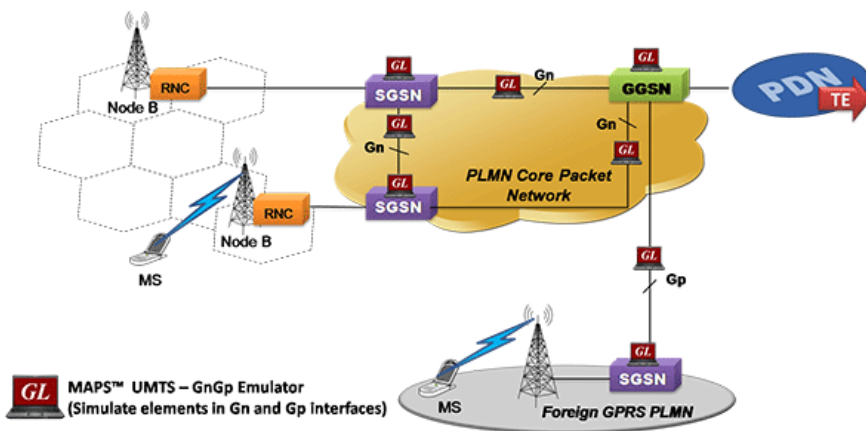

- Emulates SGSN and GGSN
- Supports GTP Control plane
- Generates hundreds of Control Signaling (Load Testing)
- Generates and processes GTP messages
- Supports GTP Traffic (GTP User Plane Data) which includes: verification like BERT testing, HTTP traffic generation capability, GGSN can actually be connected to real IP network to simulate Gateway testing

- Mobile traffic core – GTP (ETH101) simulation for user-plane packet transmission and reception services
- Mobile Traffic Core – Gateway (ETH102) module allows simulation of Gateway Traffic to test media gateway telephony interfaces over IP
- Traffic simulation modules also support generation and verification of data traffic such as Email, FTP, Web (HTTP), Video, and more

UMTS-GPRS Protocol Emulation

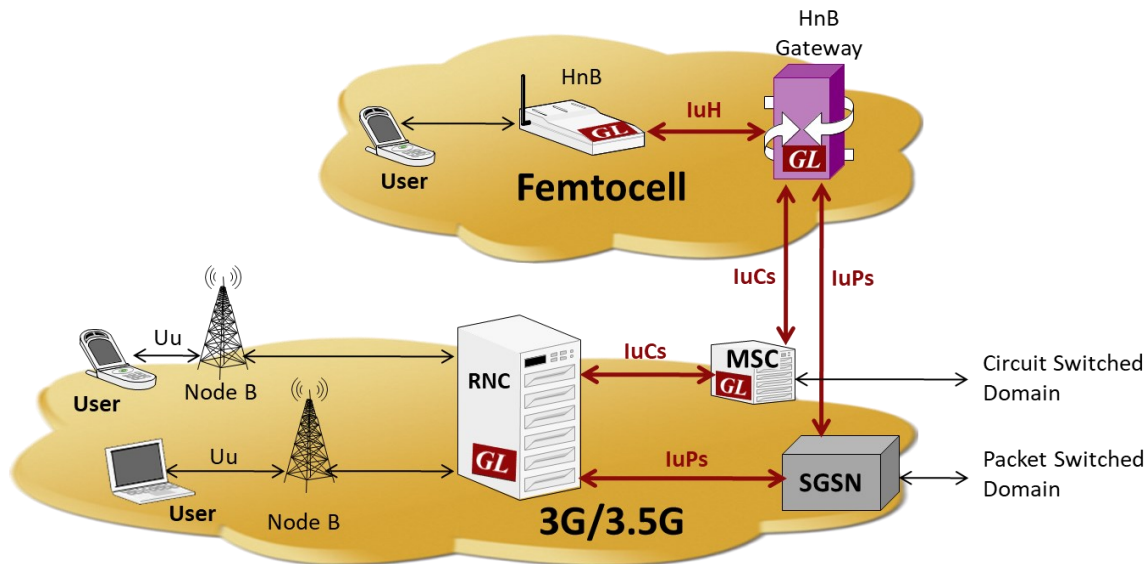

MAPS™ UMTS IuCS & IuH Emulator (over IP)

- Simulates RNC, MSC, Home NodeB (HnB) and Home NodeB Gateway (HN GW) entities
- Generates and process all Mobility Management, Session Management, RANAP and DTAP messages
- User controlled access to RANAP, and DTAP messages
- Ready scripts for Mobile Originating, Mobile Terminating, Location Updating procedures for quick testing
- Supports RTP traffic generation and reception (requires additional license)
- Supported all industry standard codecs

MAPS™ UMTS IuCS Emulator (over ATM)

- Decode different control plane protocols i.e. NBAP, RNSAP, RANAP, ALCAP, SSCOP etc
- Decode different user plane protocols i.e. Iu-UP, Iu-FP, AMR etc
- Decode NAS protocols (i.e. CC/ MM/ SM/ SMS/ GMM) along with the UTRAN specific protocols
- Supports various traffic types including Tone, Digits and File playback over AAL2
- Industry proven Protocol Analyzer for Unchannelized ATM (AAL2, AAL5), UMTS, and PPP (IP and higher layer protocols) stream
- Capturing, decoding and performing test measurements across UMTS interfaces - Iub, Iur, IuCS and IuPS

MAPS™ UMTS IuPS Emulator (over IP)

- Emulate RNC, and SGSN entities
- Generates and supports all Mobility Management, Session Management, RANAP and DTAP messages
- User controlled access to RANAP, and DTAP messages
- Ready scripts for Routing Area Updating, GPRS Attach, and Detach procedures for quick testing
- Supports Authentication, TMSI Reallocation, Encryption, and other optional procedures
- Supports mobile traffic simulation with additional licenses

UMTS-GPRS Protocol Emulation

MAPS™ luPC Interface Emulator - Locations Services

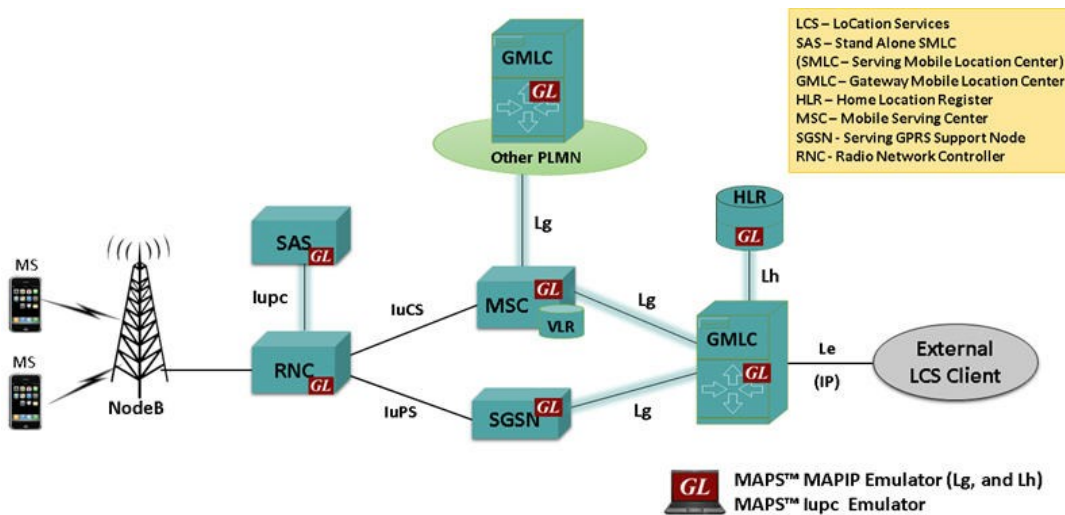

[MAPS™ UMTS luPC interface emulator](#) supports emulation of location service operation using PCAP (Positioning Calculation Application Part) protocol between the Radio Network Controller (RNC) and the Stand-Alone SMLC (SAS) and the associated signaling procedures as per 3GPP TS 25.305 specification.

- Useful tool to perform Location services testing over RNC <-> SAS luPC interface

- Emulate RNC (Radio Network Controller) and SAS (Stand-Alone SMLC) nodes in UTRAN
- PCAP protocol is used for signaling message exchange over the luPC interface
- Emulator can be configured as RNC, SAS nodes and study the call flow and exchange of PCAP signaling messages
- User-friendly GUI for PCAP signaling message exchange over M3UA/SCTP and SCCP
- Provides protocol trace with full message decoding of the PCAP signaling messages

Testing Interworking Functions & Services (MAP, CAMEL, INAP, BICC)

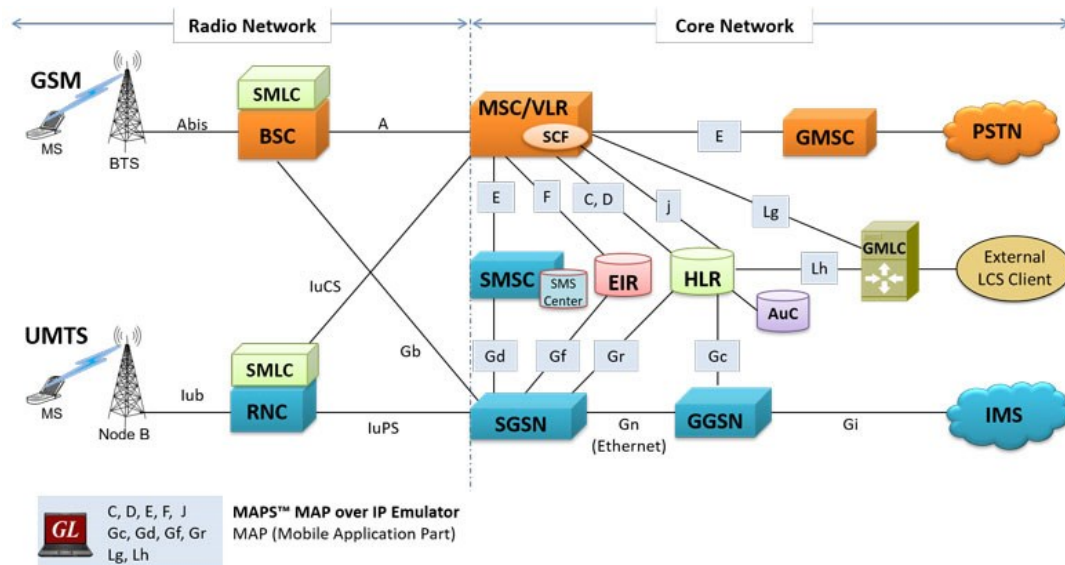

GL's Multi-protocol software solution is designed to simulate complex signaling scenarios arising during roaming.

[MAPS™ MAP](#), [MAPS™ CAP](#), [MAPS™ INAP](#), [MAPS™ BICC](#), products can fully test IWF (Inter-Working function) products and ensure full interoperability between vendors and network devices.

Common services provided by

UMTS MAP are "[Location Services](#)", "Location Tracking", "Roaming", "Subscription Information", "[Short Message Service](#)", and many more.

MAPS™ CAP Emulator can emulate CAP (CAMEL Application Part) supplementary services over GSM and UMTS networks such as unified messaging, prepaid, and toll-free (Freephone).